



X3-Hybrid G4

**5 kW / 5.5 kW / 6 kW / 8 kW
8.3 kW / 10 kW / 12 kW / 15 kW**

User Manual

Version 3.0

www.solaxpower.com



eManual in the QR code or
at <http://kb.solaxpower.com/>

STATEMENT

Copyright

Copyright © SolaX Power Network Technology (Zhejiang) Co., Ltd. All rights reserved.

No part of this manual may be reproduced, transmitted, transcribed, stored in a retrieval system, or translated into any language or computer language, in any form or by any means without the prior written permission of SolaX Power Network Technology (Zhejiang) Co., Ltd.

Trademarks



SOLA X and other symbol or design (brand name, logo) that distinguishes the products or services offered by SolaX has been trademark protected. Any unauthorized use of the above stated trademark may infringe the trademark right.

Notice

Please note that certain products, features, and services mentioned in this document may not be within the scope of your purchase or usage. Unless otherwise specified in the contract, the contents, information, and recommendations presented in this document are provided "as is" by SolaX. We do not provide any warranties, guarantees, or representations, whether express or implied.

The content of the documents is reviewed and updated as needed. However, occasional discrepancies may occur. SolaX retains the right to make improvements or changes in the product(s) and the program(s) described in this manual at any time without prior notice.

The images included in this document are solely for illustrative purposes and may differ based on the specific product models.

For more detailed information, kindly visit the website of SolaX Power Network Technology (Zhejiang) Co., Ltd. at www.solaxpower.com.

SolaX retains all rights for the final explanation.

About This Manual

Scope of Validity

This manual is an integral part of X3-Hybrid G4 series inverter. It describes the transportation, storage, installation, electrical connection, commissioning, maintenance and troubleshooting of the product. Please read it carefully before operating.

This manual is valid for the following inverter models:

- X3-Hybrid-5.0-D
- X3-Hybrid-6.0-D
- X3-Hybrid-8.0-D
- X3-Hybrid-10.0-D
- X3-Hybrid-10.0K-D
- X3-Hybrid-12.0-D
- X3-Hybrid-12.0K-D
- X3-Hybrid-15.0-D
- X3-Hybrid-5.5-D LV
- X3-Hybrid-8.3-D LV

Model description

X3-Hybrid-5.5-D LV



Item	Meaning	Description
1	Product family name	"X3-Hybrid": energy storage series inverter that supports grid connection of photovoltaic system.
2	Power	"5.5": rated output power of 5.5 kW.
3	Configuration version	"D": with DC switch
4	Voltage	"LV": low voltage

* X3-Hybrid-10.0K-D and X3-Hybrid-12.0K-D are in compliance with C10/11.

The rated AC voltage of X3-Hybrid-5.5-D LV and X3-Hybrid-8.3-D LV is 220 V / 127 V. The rated AC voltage of other models are 415 / 240 V, 400 / 230 V, and 380 / 220 V.





Target Group

The installation, maintenance and grid-related setting can only be performed by qualified personnel who:

- Are licensed and / or satisfy state and local regulations.
- Have good knowledge of this manual and other related documents.

Conventions

The symbols that may be found in this manual are defined as follows.

Symbol	Description
	Indicates a hazardous situation which, if not avoided, will result in death or serious injury.
	Indicates a hazardous situation which, if not avoided, could result in death or serious injury.
	Indicates a hazardous situation which, if not avoided, could result in minor or moderate injury, device damage, power generation loss or unanticipated results.
	Provides tips for the optimal operation of the product.

Change History

Version 3.0 (2024-06-28)

Added "2.3 Supported Power Grid", "2.5 Working Principle", "2.6 Working State", "3 System Overview", "4 Transportation and Storage", "11 Operation on SolaX App and Web", "13 Decommissioning", "15 Appendix".

Table of Contents

1	Safety	1
1.1	General Safety	1
1.2	Safety Instructions of PV, Inverter and Grid	1
1.2.1	Safety Instructions of PV	2
1.2.2	Safety Instructions of Inverter	2
1.2.3	Safety Instructions of Utility Grid	3
2	Product Overview	4
2.1	Product Introduction	4
2.2	Appearance	4
2.3	Supported Power Grid	5
2.4	Symbols on the Label and Inverter	6
2.5	Working Principle	7
2.5.1	Circuit Diagram	7
2.5.2	Application Schemes	8
2.6	Working State	10
2.7	Working mode	11
2.7.1	Self-use Mode (Priority: Loads > Battery > Grid)	11
2.7.2	Feed-in Priority (Priority: Loads > Grid > Battery)	13
2.7.3	Backup Mode (Priority: Loads > Battery > Grid)	14
2.7.4	Peak Shaving Mode	16
2.7.5	TOU Mode	17
2.7.6	EPS (off-grid) Mode (Priority: Loads > Battery)	18
2.7.7	Manual Mode	19
2.7.8	Export Control Function	19
3	System Overview	21
4	Transportation and Storage	24
5	Preparation before Installation	25
5.1	Selection of Installation Location	25
5.1.1	Environment Requirement	25
5.1.2	Installation Carrier Requirement	27
5.1.3	Clearance Requirement	27
5.2	Tools Requirement	29
5.3	Additionally Required Materials	30

- 6 Unpacking and Inspection 31**
 - 6.1 Unpacking.....31
 - 6.2 Scope of Delivery.....32
- 7 Mechanical Installation 34**
 - 7.1 Dimensions for Mounting35
 - 7.2 Installation Procedures.....35
- 8 Electrical Connection 38**
 - 8.1 Overview of Electrical Connection38
 - 8.1.1 Terminals and Parts of Inverter38
 - 8.1.2 Cable Connections of Inverter.....40
 - 8.2 PE Connection42
 - 8.3 AC Connection.....44
 - 8.4 PV Connection48
 - 8.5 Battery Power Cable Connection.....52
 - 8.6 Communication Connection.....56
 - 8.6.1 COM Communication Connection.....56
 - 8.6.2 BMS Communication Connection58
 - 8.6.3 Meter/CT Connection.....60
 - 8.6.4 CAN1 / CAN2 / DRM / OFF Communication Connection.....64
 - 8.7 Monitoring Connection69
- 9 System Commissioning 72**
 - 9.1 Checking before Power-on72
 - 9.2 Powering on the System.....72
 - 9.3 Checking after Power-on74
 - 9.4 Operation of Lockable DC Switch74
- 10 Operation on LCD..... 77**
 - 10.1 Introduction of Control Panel.....77
 - 10.2 Introduction of Main Interface.....78
 - 10.3 Introduction of Submenus Interface.....78
 - 10.4 System ON/OFF.....81
 - 10.5 Mode Select81
 - 10.6 System Status82
 - 10.7 History Data.....84
 - 10.8 Setting86
 - 10.8.1 User Setting.....86
 - 10.8.2 Advanced Setting93
 - 10.9 About.....110

- 11 Operation on SolaX App and Web..... 111**
 - 11.1 Introduction of SolaXCloud.....111
 - 11.2 Operation Guide on SolaXCloud App 111
 - 11.2.1 Downloading and Installing App 111
 - 11.2.2 Operation on the App..... 111
 - 11.3 Operations on SolaXCloud Webpage..... 112
- 12 Troubleshooting and Maintenance 113**
 - 12.1 Power Off..... 113
 - 12.2 Troubleshooting..... 113
 - 12.3 Maintenance..... 122
 - 12.3.1 Maintenance Routines 122
 - 12.3.2 Upgrading Firmware..... 123
- 13 Decommissioning 125**
 - 13.1 Disassembling the Inverter 125
 - 13.2 Packing the Inverter 128
 - 13.3 Disposing of the Inverter 128
- 14 Technical Data 129**
- 15 Appendix 133**
 - 15.1 Application of Generator..... 133
 - 15.1.1 Introduction of Generator Application 133
 - 15.1.2 Notice for Generator Application..... 133
 - 15.1.3 ATS Control Mode..... 134
 - 15.1.4 Dry Contact Mode..... 136
 - 15.2 Application of Adapter Box G2 139
 - 15.2.1 Introduction of Adapter Box G2 Application..... 139
 - 15.2.2 Wiring Connection Diagram..... 139
 - 15.2.3 Communication connection with inverter..... 140
 - 15.2.4 Settings for Adapter Box G2..... 141
 - 15.3 Application of EV-Charger 142
 - 15.3.1 Introduction of EV-Charger Application 142
 - 15.3.2 Wiring Connection Diagram..... 142
 - 15.3.3 Communication Connection with Inverter..... 143
 - 15.3.4 Setting for EV-Charger..... 144
 - 15.4 Application of DataHub 145
 - 15.4.1 Introduction of DataHub Application..... 145
 - 15.4.2 Wiring Connection Diagram..... 145
 - 15.4.3 Communication Connection with Inverter..... 146

15.4.4 Settings for DataHub	147
15.5 Application of Parallel Function	148
15.5.1 Introduction of Parallel Application	148
15.5.2 Notice for Parallel Application	148
15.5.3 System Wiring Diagram	149
15.5.4 System Wiring Procedure	151
15.5.5 Settings for Parallel Connection	154
15.6 Meter/CT Connection Scenarios	155
15.6.1 Connection of CT	155
15.6.2 Connection of Direct-connected Meter	159
15.6.3 Connection of CT-connected Meter	162
15.6.4 Connection of Two Meters	165

1 Safety

1.1 General Safety

The series inverter has been meticulously designed and thoroughly tested to comply with the relevant state and international safety standards. Nevertheless, like all electrical and electronic equipment, safety precautions must be observed and followed during the installation of the inverter to minimize the risk of personal injury and ensure a safe installation.

Please thoroughly read, comprehend, and strictly adhere to the comprehensive instructions provided in the user manual and any other relevant regulations prior to the installation of the inverter. The safety instructions in this document serve as supplementary guidelines to local laws and regulations.

SolaX shall not be liable for any consequences resulting from the violation of the storage, transportation, installation, and operation regulations outlined in this document. Such consequences include, but are not limited to:

- Inverter damage caused by force majeure events, such as earthquakes, floods, thunderstorms, lightning, fire hazards, volcanic eruptions, and similar events.
- Inverter damage due to human causes.
- Usage or operation of the inverter in violation of local policies or regulations.
- Failure to comply with the operation instructions and safety precautions provided with the product and in this document.
- Improper installation or usage of the inverter in unsuitable environmental or electrical conditions.
- Unauthorized modifications to the product or software.
- Inverter damage occurring during transportation by the customer.
- Storage conditions that do not meet the requirements specified in this document.
- Installation and commissioning performed by unauthorized personnel who lack the necessary licenses or do not comply with state and local regulations.

1.2 Safety Instructions of PV, Inverter and Grid

Save these important safety instructions. Failure to follow these safety instructions may result in damage to the inverter and injury or even loss of life.

1.2.1 Safety Instructions of PV

 **DANGER!**

Potential risk of lethal electric shock associated with the photovoltaic (PV) system

- Exposure to sunlight can result in the generation of high DC voltage by PV modules, which can lead to electric shock causing severe injuries or even death.
- Never touch the positive or negative poles of the PV connecting device, and avoid touching both poles simultaneously.
- Do not ground the positive or negative poles of the PV modules.
- Only qualified personnel can perform the wiring of the PV modules.

 **WARNING!**

- Overvoltage protection with surge arresters should be provided when the PV system is installed. The inverter is fitted with SPDs on both PV input side and MAINS side.
- Please consult professionals before installing SPDs.

 **WARNING!**

- Make sure that the input DC voltage does not exceed the maximum DC input voltage specified for the inverter. Overvoltage can cause irreversible damage to the inverter, and such damage is not covered by the warranty.

NOTICE!

- PV modules should have an IEC61730 class A rating.

1.2.2 Safety Instructions of Inverter

 **DANGER!**

Potential risk of lethal electric shock associated with the inverter

- Only operate the inverter if it is in a technically faultless condition. Operating a faulty inverter may lead to electric shock or fire.
- Do not attempt to open the enclosure without authorization from SolaX. Unauthorized opening of the enclosure will void the warranty and can result in lethal danger or serious injury due to electric shock.
- Make sure that the inverter is reliably grounded before any operation to prevent the risk of electric shock causing lethal danger or serious injury.
- Only qualified personnel can perform the installation, wiring, maintenance of the inverter by following this document and the related regulations.

 **WARNING!**

- During operation, avoid touching any parts of the inverter other than the DC switch and LCD panel (if any).
- Never connect or disconnect the AC and DC connector while the inverter is running.
- Prior to conducting any maintenance, turn off the AC and DC power and disconnect them from the inverter. Wait for 5 minutes to fully discharge the energy.

 **WARNING!****Potential danger of scalding due to the hot enclosure of the inverter**

- Avoid touching the inverter while it is running, as it becomes hot during operation and may cause personal injuries.

 **WARNING!**

- When handling the battery, carefully follow all safety instructions provided in the battery manual. The battery used with the inverter must meet the specified requirements of the series inverter.

 **WARNING!**

- Use insulated tools when installing the device, and always wear personal protective equipment during installation and maintenance.

 **CAUTION!**

- Make sure that children are supervised to prevent them from playing with the inverter.
- Pay attention to the weight of the inverter and handle it properly to avoid personal injuries.
- Radiation may be harmful to health! Do not stay in the vicinity of the inverter for a long time and keep at least 20 cm away from it.

NOTICE!

- If an external Residual Current Device (RCD) is required by local regulations, verify the type of RCD required. It is recommended to use a Type-A RCD with a rating of 300 mA. When required by local regulations, the use of a Type-B RCD is permitted.
- Keep all labels and the nameplate on the inverter clearly visible and well-maintained.

1.2.3 Safety Instructions of Utility Grid

NOTICE!

- Only connect the inverter to the grid with the permission of the local utility grid company.

2 Product Overview

2.1 Product Introduction

The X3-Hybrid G4 is an energy storage series inverter that supports grid connection of photovoltaic system. It has up to 200% PV mega-capacity, high charging and discharging efficiency, and built-in shadow tracking. The inverter is IP65 rated and supports high power solar panels for durability and compatibility in low temperatures. In addition, it can easily store surplus energy and enable intelligent load management.

2.2 Appearance

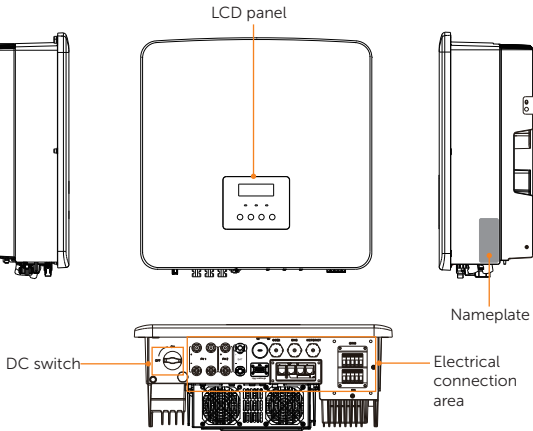

Figure 2-1 Appearance

Table 2-1 Description of appearance

Item	Description
Nameplate	Nameplate clearly identifies the device type, serial number, specific DC / AC parameters, certification, etc.
LCD panel	Including screen, indicators and keys. Screen displays the information; indicators indicate the status of inverter. Keys are used to perform the parameter setting.
DC switch	Disconnect the DC input when necessary.
Electrical connection area	Including PV terminals, battery terminals, Grid connection terminals, EPS (off-grid) terminals, communication terminals, etc.

2.3 Supported Power Grid

There are different ways of wiring for different grid systems. TT / TN-S / TN-C-S are shown as below: * For 5.5 kW and 8.3 kW inverter, Phase-Neutral voltage is 127 V and Phase-Phase voltage is 220 V.

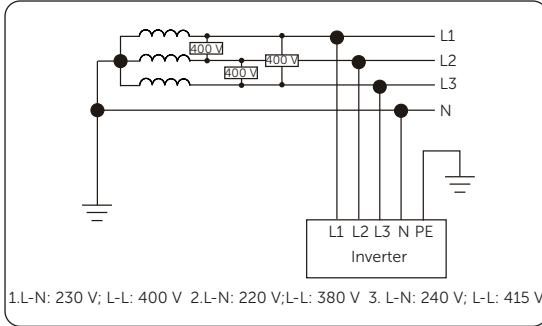

Figure 2-2 Supported power grid-TT

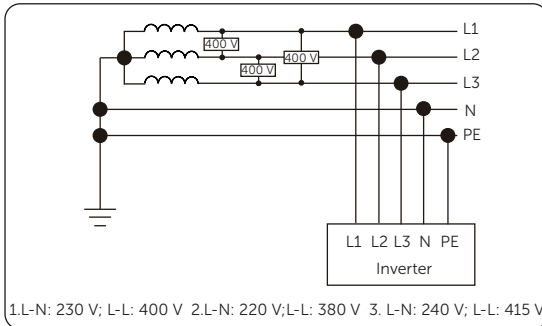

Figure 2-3 Supported power grid-TN-S

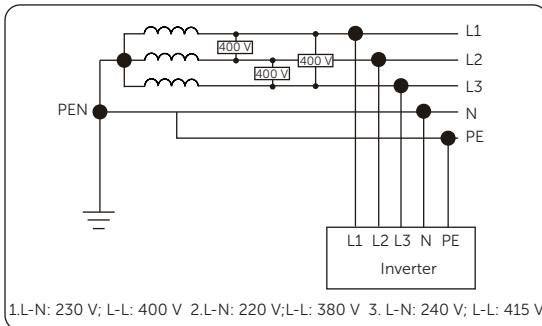













Figure 2-4 Supported power grid-TN-C-S

2.4 Symbols on the Label and Inverter

Table 2-2 Description of symbols

Symbol	Description
	CE mark. The inverter complies with the requirements of the applicable CE guidelines.
	TUV certified.
	RCM mark. The inverter complies with the requirements of the applicable RCM guidelines.
	Additional grounding point.
	Beware of hot surface. Do not touch a running inverter, as the inverter becomes hot during operation!
	Risk of electric shock. High voltage exists after the inverter is powered on! Do not open the enclosure of the running inverter.
	Risk of danger. Potential hazards exist after the inverter is powered on!
	Read the enclosed documentations and operate the inverter according to the documentations.
	Do not dispose of the inverter together with household waste.
	Do not operate this inverter until it is isolated from battery, mains and on-site PV generation source.
	Danger of high voltage. Do not touch live parts for 5 minutes after disconnection from the power sources.

2.5 Working Principle

2.5.1 Circuit Diagram

The inverter is equipped with multi-channel MPPT for DC input to ensure maximum power even under different photovoltaic input conditions. The inverter unit converts direct current generated from PV module or battery into alternating current that meets the requirements of the power grid and feeds it into the power grid or supplies to the load. The principle design of inverter is shown in the figure below:

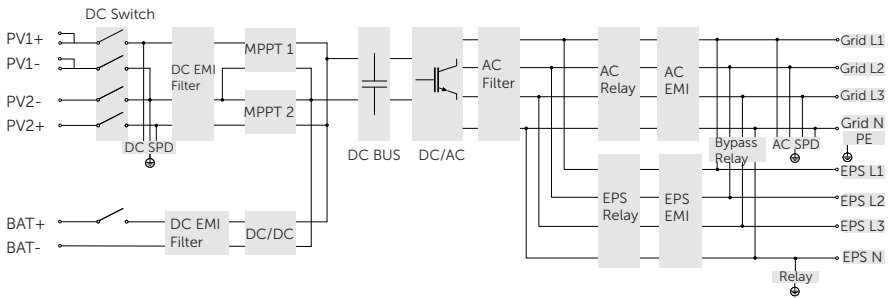

Figure 2-5 Circuit Diagram for X3-Hybrid G4 series inverter

NOTICE!

- For 5 kW and 6 kW inverter, PV 1 MPPT connects one string only.

2.5.2 Application Schemes

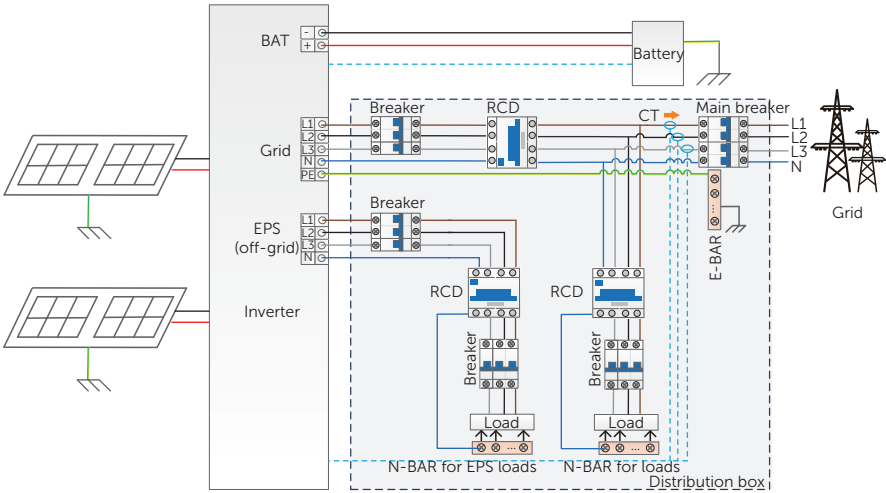

Figure 2-6 Partial home backup for Europe

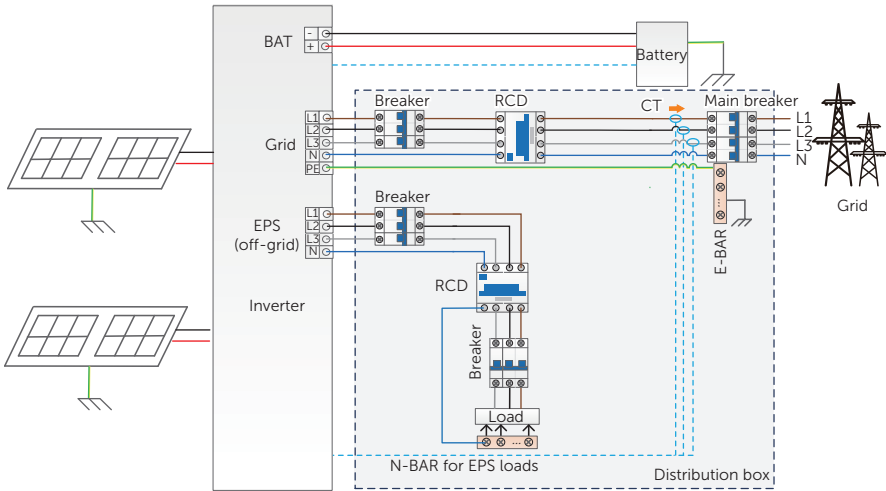

Figure 2-7 Whole home backup for Europe

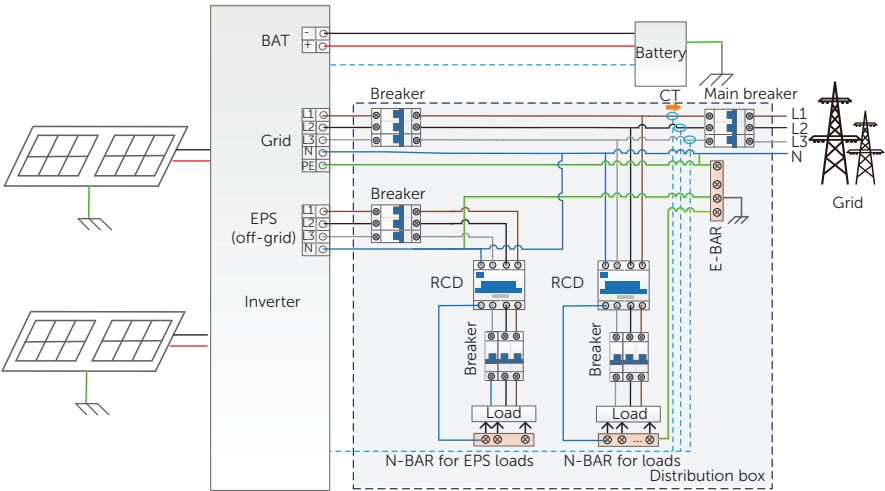

Figure 2-8 Partial home backup for Australia

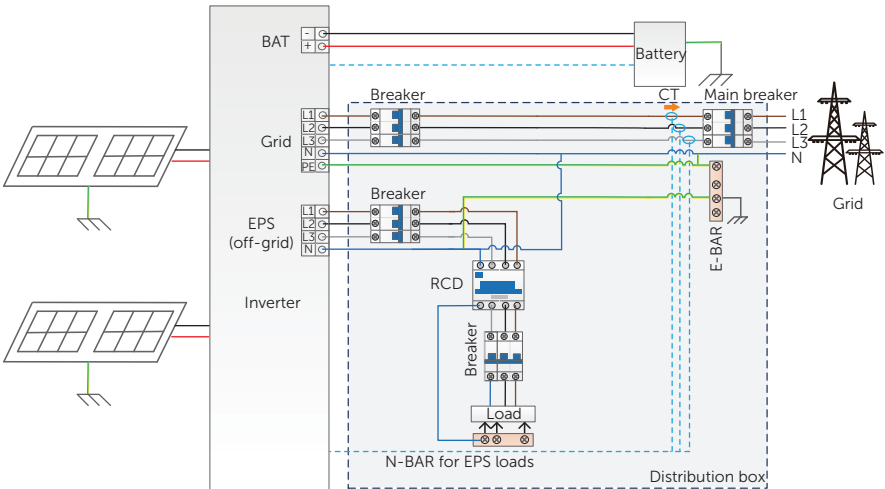

Figure 2-9 Whole home backup for Australia

NOTICE!

- Only qualified personnel can perform the wiring connection of the inverter.
- When power cuts suddenly, the inverter connects the N line of EPS (Off-grid) load with the ground through relay, providing a fixed zero potential for EPS (Off-grid) load and ensuring the safety of electricity use by users.

2.6 Working State

The series inverter has Waiting, Checking, Normal, EPS Checking, EPS, Fault, Self-testing, Upgrading, Idle and Standby state.

Table 2-3 Description of working state

State	Description
Waiting	<ul style="list-style-type: none"> The inverter is waiting for the conditions to be met in order to enter Checking state.
Checking	<ul style="list-style-type: none"> The inverter is checking for conditions to enter Normal state.
Normal	<ul style="list-style-type: none"> The inverter is working normally.
EPS Checking	<ul style="list-style-type: none"> The inverter is checking for conditions to enter EPS (off-grid) state.
EPS	<ul style="list-style-type: none"> The inverter is working in EPS (off-grid) state.
Fault	<ul style="list-style-type: none"> The inverter detects error and prompts error code.
Self-testing	<ul style="list-style-type: none"> The inverter is self-testing. (Only applicable for CEI 0-21)
Upgrading	<ul style="list-style-type: none"> The inverter is upgrading DSP, ARM, or BMS.
Idle	<ul style="list-style-type: none"> When the battery SOC reaches the minimum SOC and there is no sufficient PV input voltage, the battery goes into hibernation and the inverter enters Idle state.
Standby	<ul style="list-style-type: none"> When the power of load is extremely low and there is no sufficient PV input voltage, or a state when the battery SOC is more than or equal to 10% and there is no sufficient PV input voltage, the inverter enters Standby state. In this state, it detects PV connection, load power, battery forced charged, etc to determine whether to exit Standby state and enter Normal state.

NOTICE!

- When the inverter is in an idle state, you can reset the working mode, the Min SOC and the charging periods through the inverter LCD or the SolaX APP to charge the battery to the Min SOC in the charging periods and then awaken the inverter. Please make sure that the actual battery SOC minus the modified Min SOC is $\geq 2\%$ under a specific working mode, so that other modifications are effective. When the current system time is within the new charging periods you reset, the battery begins charging.

2.7 Working mode

Six working modes are available for you to choose in on-grid status, i.e Self use, Feed-in priority, Backup, Peak shaving, TOU and Manual. You can choose the working modes according to your lifestyle and environment.

When the power supply from the electric power company is stopped due to a power outage, it automatically switches to EPS (off-grid) mode and connects to the distribution board for a specific load, thereby providing power to important electrical appliances.

For how to set the working mode, please refer to the section "10.7.1 User Setting".

2.7.1 Self-use Mode (Priority: Loads > Battery > Grid)

The self-use mode is suitable for areas with low feed-in subsidies and high electricity prices. The power of PV will supply the loads first, and the surplus power will charge the battery, then the remaining power will feed into the grid.

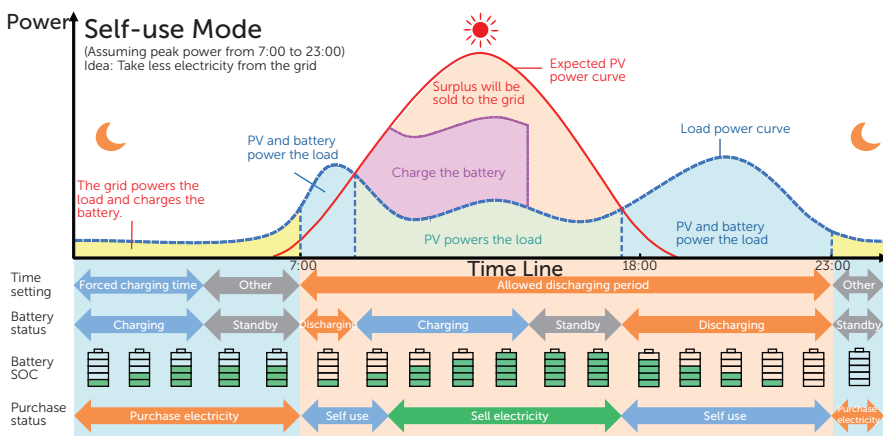

Figure 2-10 Self-use mode

Table 2-4 Description of self-use mode

Time period	Inverter working status
Forced charging period	<ul style="list-style-type: none"> Charge the battery first until the battery SOC reaches the specified Charge battery to value. You can configure the inverter to either draw power from the grid or not.

Time period	Inverter working status
Allowed discharging period	PV is sufficient (PV → load → battery → grid) <ul style="list-style-type: none">The power generated from PV prioritizes supplying the load. Any excess power is then directed towards charging the battery, and if there is still surplus electricity, it can be sold to the grid. In the event that the local utility restricts the sale of electricity to the grid, the Export Control value can be set on the inverter. Please refer to "Setting Export Control".
	PV is insufficient (PV+battery → load) <ul style="list-style-type: none">The battery discharges power to the load, and once its capacity reaches Min SOC, it automatically ceases discharging.

Note:

Charge battery to: The battery SOC charged from grid. 10% by default, range is 10%~100%.

Min SOC: Minimum SOC of the battery under grid connection. 10% by default, range is 10%~100%.

Export Control: The power exported to the grid. 300000 W by default.

Charge & Discharge Period

You can set two configurable working periods: forced charging period and allowed discharging period. The interval not in the charging & discharging period belongs to other time periods.

- Forced charging period (Default period: 00:00~00:00, closed by default)

In the forced charging period, the inverter will charge the battery first until the battery SOC reaches the specified **Charge battery to** value set in each working mode. You have the option to configure the inverter to either draw power from the grid or not.

- Allowed discharging period (Default period: 00:00~23:59)

In the allowed discharging period, the inverter will allow the battery to discharge and charge power in accordance with the working mode and load conditions.

- Period not set as forced charging or allowed discharging period

In this period, the inverter will allow the battery to charge but can not discharge power.

NOTICE!

- The charging and discharging period is only applicable for self-use mode, feed-in priority and backup mode. The priority of forced charging period is higher than all working modes.

2.7.2 Feed-in Priority (Priority: Loads > Grid > Battery)

The feed-in priority mode is suitable for areas with high feed-in subsidies. The power generated from PV is directed towards supplying the loads. Any excess power beyond the load requirements will be fed into the grid.

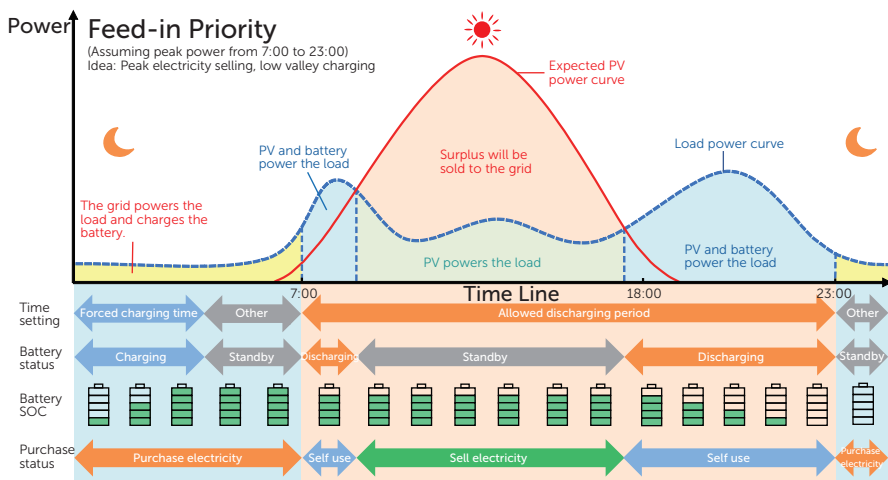

Figure 2-11 Feed-in priority

Table 2-5 Description of feed-in priority

Time period	Inverter working status
Forced charging period	<ul style="list-style-type: none"> Charge the battery first until the battery SOC reaches the specified Charge battery to value. You can configure the inverter to either draw power from the grid or not.
Allowed discharging period	<p>PV is sufficient (PV → load → grid)</p> <ul style="list-style-type: none"> The power generated from PV is directed towards supplying the loads. Any excess power beyond the load requirements will be fed into the grid. <p>PV is insufficient (PV+battery → load)</p> <ul style="list-style-type: none"> PV and battery supply power to the load at the same time, and once the battery capacity reaches Min SOC, it automatically ceases discharging.

Note:

Charge battery to: The battery SOC charged from grid. 50% by default, range is 10%~100%.

Min SOC: Minimum SOC of the battery under grid connection. 10% by default, range is 10%~100%.

NOTICE!

- You can set two configurable working periods: forced charging period and allowed discharging period. Please refer to "Charge & Discharge Period" for details.
- In feed-in priority mode, considering whether the battery can be charged during the daytime. If not, it is recommended to set forced charging period during off-peak hours.

2.7.3 Backup Mode (Priority: Loads > Battery > Grid)

The backup mode is suitable for areas with frequent power outages.

This mode will maintain the battery capacity at relatively high level to ensure that the emergency loads can be used when the grid is off. Same working logic with self-use mode.

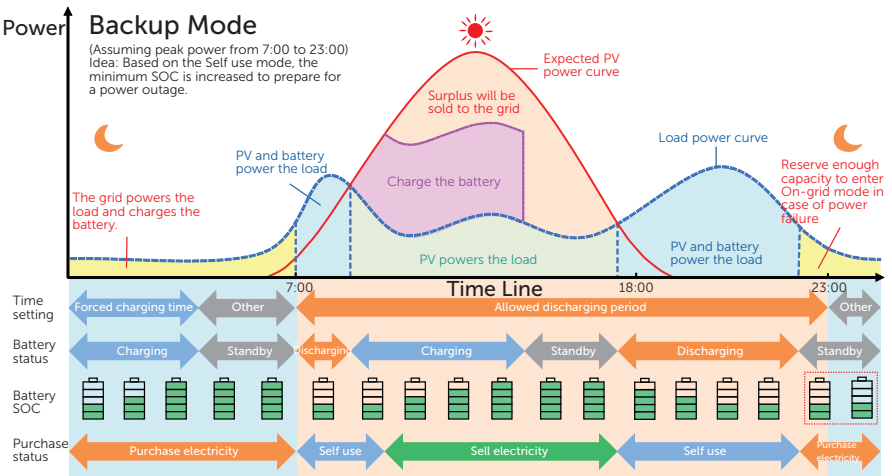

Figure 2-12 Backup mode

Table 2-6 Description of backup mode

Time period	Inverter working status
Forced charging period	<ul style="list-style-type: none"> • Charge the battery first until the battery SOC reaches the specified Charge battery to value. You can configure the inverter to either draw power from the grid or not.

Time period	Inverter working status
Allowed discharging period	<p>The working logic remains the same as for self-use mode. The difference lies in:</p> <ul style="list-style-type: none"> In self-use mode, the battery goes into hibernation when PV input is not available and the battery SOC reaches Min SOC (on-grid min SOC). In the event of a grid outage, the inverter will not enter EPS (off-grid) mode. In backup mode, the inverter enters a standby state when PV input is not available and the battery SOC reaches Min SOC (on-grid min SOC). In the event of a grid outage, it will switch to EPS (off-grid) mode until the battery discharges to Min SOC (Off-grid min SOC).

Note:

Charge battery to: The battery SOC charged from grid. 50% by default, range is 30%~100%.

Min SOC (on-grid min SOC): Minimum SOC under grid connection. 30% by default, range is 30%~100%.

Min SOC (off-grid min SOC): Minimum SOC under off-grid conditions. 10% by default, range is 10%~25%.

NOTICE!

- You can set two configurable working periods: forced charging period and allowed discharging period. Please refer to "[Charge & Discharge Period](#)" for details.
- If there is a foreseeable power outage, switch from other working modes to the backup mode in advance.

2.7.4 Peak Shaving Mode

Peak shaving mode is set for leveling out peaks in electricity use. The system is intelligently controlled to ensure charging takes place during off-peak hours and discharging occurs during peak hours.

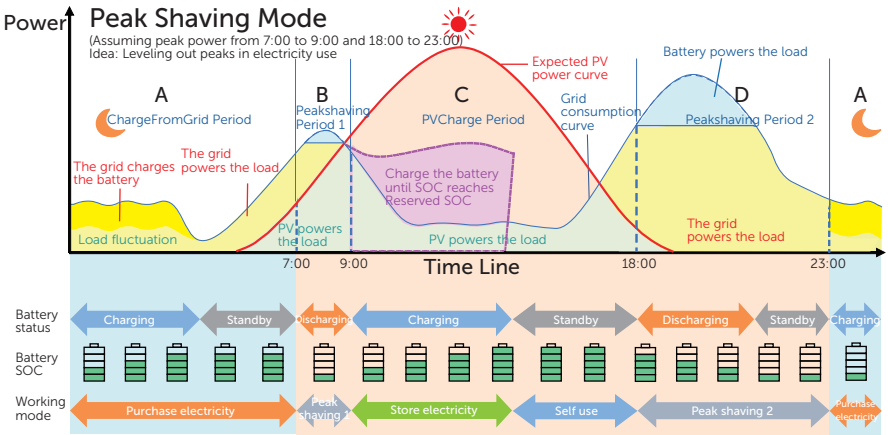

Figure 2-13 Peakshaving mode

Table 2-7 Description of peakshaving mode

Time Period	Inverter working status
Period A	<ul style="list-style-type: none"> The grid can charge the battery to MaxSOC within the set ChargePowerLimits. In this period, the battery will not discharge power.
Period B & D	<p>Grid consumption power < PeakLimits (PV+grid → load)</p> <ul style="list-style-type: none"> The PV and grid will power the load. The battery will not charge or discharge power.
Period C	<p>Grid consumption power > PeakLimits (PV + battery+grid → load)</p> <ul style="list-style-type: none"> The battery will discharge power for loads and thus reduce the amount of power purchased from the grid. <p>(PV → battery → load → grid)</p> <ul style="list-style-type: none"> The battery does not discharge power. The PV charges the battery up to the Reserved SOC before supplying power to the loads. Any excess power beyond the load requirements is fed into the grid.

Note:

MaxSOC: The energy taken from grid to charge the battery. 50% by default, range is 10%-100%.

ChargePowerLimits: The charging power from grid. 1000 W by default, range is 0-60000 W.

PeakLimits: The load consumption power from grid side. 0 W by default, range: 0-60000 W.

Reserved SOC: The lower limit of battery SOC required for later peak shaving period. 50% by default, range is 10~100%.

2.7.5 TOU Mode

In TOU mode, different working modes, i.e Self-use, Feed-in Priority, Peak shaving, Charging, Discharging and battery off can be set for different time slots in accordance with actual needs and environment conditions through SolaX Cloud App or Web.

The day can be divided into up to 10 time slots, and the minimum time slot is 15 minutes, independent working mode can be set for each time slot. Please refer to web guide or App guide for details about how to set the TOU mode.

Table 2-8 Time slot set

Time Slot	Working Mode
x:xx~x:xx (e.g 0:00~0:15)	Choose one mode from Self-use / Feed-in Priority / Peak shaving / Charging / Discharging / Battery off

Note:

Self-use: Same working logic with "2.7.1 Self-use Mode", but it is not limited by the charging and discharging period.

Feed-in Priority: Same working logic with "2.7.2 Feed-in Priority", but it is not limited by the charging and discharging period.

Peak shaving: The working logic is that when the power consumption from the grid exceeds the set **PeakLimits** value, the battery is allowed to discharge power. The excess power beyond the limit is provided by the combination of photovoltaic and battery to ensure that the maximum power purchased from the grid does not exceed the set limit. You need to set the **PeakLimits** value through Web or App when choosing Peak shaving mode.

Charging: If allowed by the battery, the system charges the battery from the grid with a specified power based on the set output percentage, controlling the power at the AC terminal. You need to set the **RatePower (%)** through Web or App when choosing Charging mode.

Discharging: If allowed by the battery, the system outputs a specified power from the grid based on the set output percentage, controlling the power at the AC port. You need to set the **RatePower (%)** through Web or App when choosing Discharging mode.

Battery off: The battery neither charges nor discharges power. The power of PV will supply to loads or feed into the grid. Only when the battery SOC is lower than the system (TOU) **Min SOC**, the battery can be charged.

2.7.6 EPS (off-grid) Mode (Priority: Loads > Battery)

During a power outage, the system will provide uninterrupted power supply to the EPS (off-grid) loads using the power from PV and the battery. It is important to ensure that the EPS (off-grid) loads should not exceed the maximum output power of the battery.

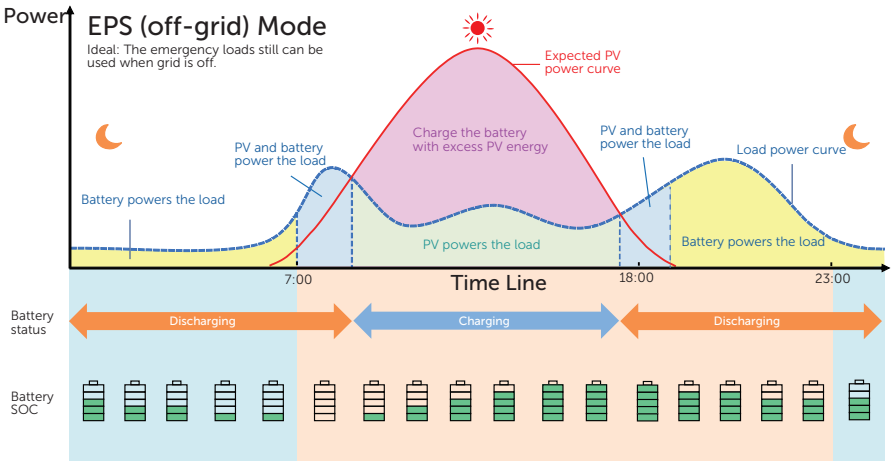

Figure 2-14 EPS (off-grid) mode

Table 2-9 Description of EPS (off-grid) mode

Battery SOC	Inverter working status
Battery SOC > Min SOC (off-grid min SOC)	<p>PV is sufficient (PV → load → battery)</p> <ul style="list-style-type: none"> The PV prioritizes supplying power to the load, with any excess energy being directed towards charging the battery.
Battery SOC ≤ Min SOC (off-grid min SOC)	<p>PV is insufficient (PV+battery → load)</p> <ul style="list-style-type: none"> The PV prioritizes supplying power to the load. If the energy is not enough, the battery will discharge power until the battery SOC reaches Min SOC and then error of BatPowerLow will be reported. <p>The inverter reports BatPowerLow. When there is PV, it will charge the battery first. After charging to the set Min ESC SOC value, it will be automatically recovered and enter EPS (off-grid) mode again.</p>

Note:

Min SOC: Minimum SOC of the battery under off-grid conditions. 10% by default, range: 10%-100%.

Min ESC SOC: The minimum SOC required for re-entry EPS (off-grid) mode. 30% by default, range: 15%-100%.

2.7.7 Manual Mode

This working mode is only for the qualified personnel to perform debugging and maintenance. It includes **Forced Discharge**, **Forced Charge** and **Stop Chrg&Dischrg**. The system will restore to the original working mode after six hours **Manual** mode is set.

2.7.8 Export Control Function

Export control is a limit on the amount of energy your solar system can export into the grid. You have a set limit on how much energy you can export to the grid. The series inverter supports **Phase Unbalance** output and phase balance output. The figure below will take zero export control with **Phase Unbalance** function as an example.

How Export Control works

- CT/meter required
- Correct setting of the limit value of **Export Control** through the inverter. (For parallel system, set on the master inverter)

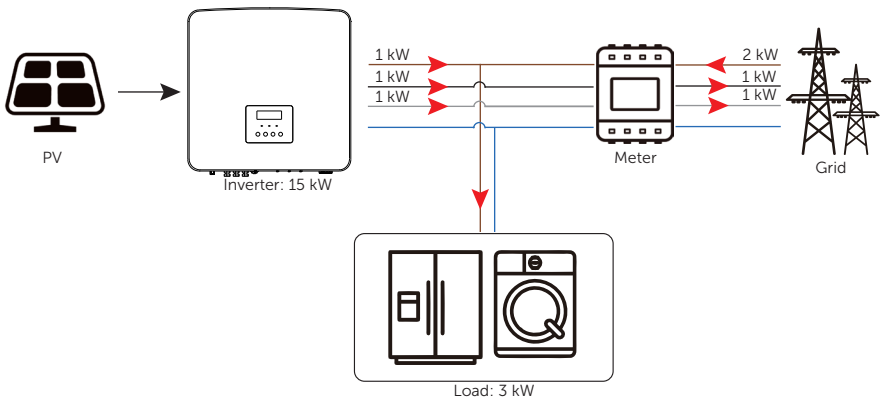

Figure 2-15 Zero export control with **Phase Unbalance** disabled

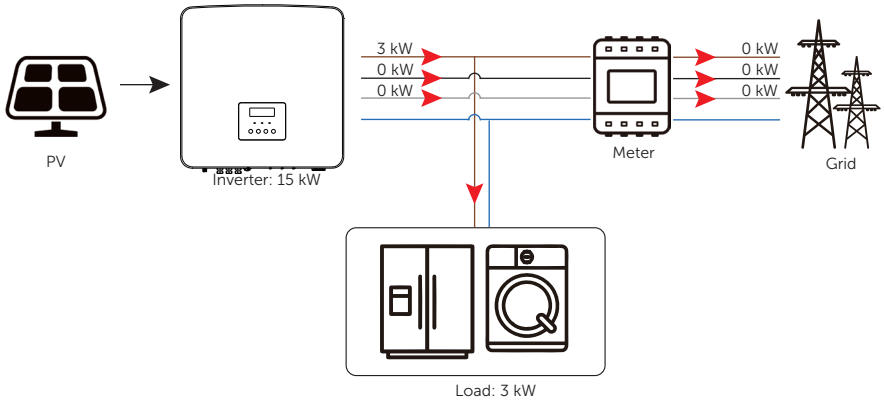

Figure 2-16 Zero export control with **Phase Unbalance** enabled

Note:

For how to set the **Export Control** function, please refer to "[Setting Export Control](#)".

3 System Overview

System Overview

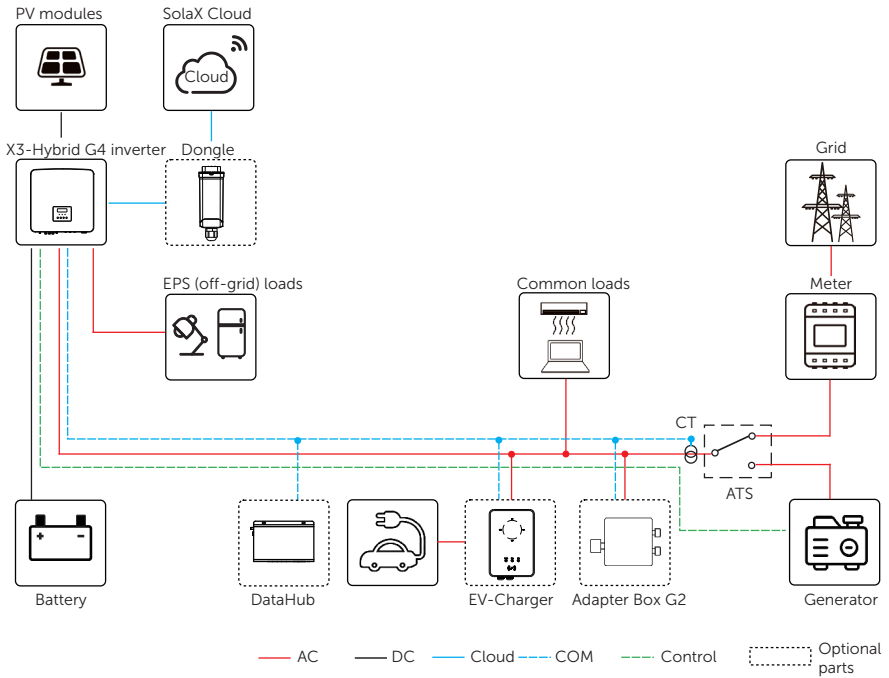

Figure 3-1 System diagram

NOTICE!

- X3-Hybrid G4 series inverter also supports to connect Adapter Box G1 through dry contact. Please refer to Adapter Box G1 installation guide for details.

Table 3-1 System item description

Item	Description
X3-Hybrid G4 series (the device covered in this manual)	The X3-Hybrid G4 series is an energy storage inverter that supports grid connection of a photovoltaic system.
PV modules	PV modules work in MPPT mode. 5 kW and 6 kW inverters: one string for each MPPT Other models: two strings for MPPT 1 and one string for MPPT 2
Battery	The series inverter should be coupled with lithium-ion battery or lead-acid battery. It communicates with the inverter via BMS and must comply with the specifications of the regulations.
Meter/CT	The meter/CT is used by the inverter for import / export or consumption readings, and manages the battery charge / discharge accordingly for smart energy management applications.
Adapter Box G2 (optional)	With SolaX Adapter Box G2, you can connect the smart heat pump to the energy storage systems, realizing the control of the heat pump through inverter. Please refer to "15.2 Application of Adapter Box G2" for specific wiring and setting.
DataHub (optional)	SolaX DataHub is a professional device that for monitoring platforms of photovoltaic power generation systems, which enables data collection, storage, output control, centralized monitoring, and centralized maintenance of devices such as inverters, electricity meters, and environmental monitoring instruments in photovoltaic power generation systems. Please refer to "15.4 Application of DataHub" for specific wiring and setting.
EV-Charger (optional)	The series inverter can communicate with SolaX EV-Charger to form an intelligent photovoltaic, storage and EV charging energy system, thus maximizing the utilization of photovoltaic energy. Please refer to "15.3 Application of EV-Charger" for specific wiring and setting.
Generator (supported)	SolaX PV-Genset solution ensures optimum interaction between the photovoltaics and diesel generator, which saves fuel, lowers energy costs and ensures a stable and reliable power supply. Please refer to "15.1 Application of Generator" for specific wiring and setting.
Grid	415 V / 240 V, 400 V / 230 V and 380 V / 220 V grid are supported. (For 5.5 kW and 8.3 kW inverter, 220 V / 127 V grid is supported.)

Item	Description
SolaX Cloud	SolaX Cloud is an intelligent, multifunctional monitoring platform that can be accessed either remotely or through a hard wired connection. With the SolaX Cloud, the operators and installers can always view key and up-to-date data.

4 Transportation and Storage

If the inverter is not put into use immediately, the transportation and storage requirements need to be met:

Transportation

- Observe the caution signs on the packaging of inverter before transportation.
- Pay attention to the weight of the inverter. Carry the inverters by the required number of personnel as specified by local regulations. (gross weight of X3-Hybrid G4: 34 ± 1 kg)
- Wear protective gloves when carrying the inverter by hand to prevent injuries.
- When lifting up the inverter, hold the handle position and the bottom position of the carton. Keep the inverter horizontal in case of falling down.

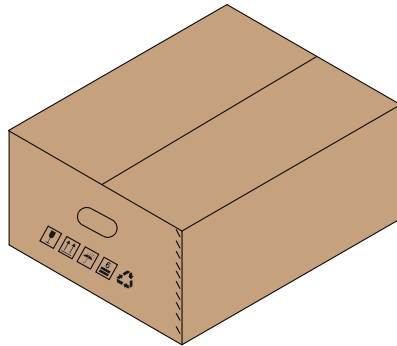

Figure 4-1 Caution signs on the packaging

Storage

- The inverter must be stored indoors.
- Do not remove the original packaging material and check the outer packaging material regularly.
- The storage temperature should be between -40°C and $+70^{\circ}\text{C}$. The relative humidity should be between 35%RH and 70%RH.
- Stack the inverter in accordance with the caution signs on the inverter carton to prevent their falling down and device damage. Do not place it upside down.

5 Preparation before Installation

5.1 Selection of Installation Location

The installation location selected for the inverter is quite critical in the aspect of the guarantee of inverter safety, service life and performance. It has the IP65 ingress protection, which allows it to be installed outdoor. The installation position shall be convenient for wiring connection, operation and maintenance.

5.1.1 Environment Requirement

- The ambient temperature: -35°C to $+60^{\circ}\text{C}$.
- The relative humidity shall be between 4-100%RH.
- Do not install the inverter in the areas where the altitude exceeds 3000 m.
- Install the inverter in a well-ventilated environment for heat dissipation.
- Do not install the inverter in areas with flammable, explosive and corrosive materials or near antennas.
- Avoid direct sunlight, rain exposure and snow accumulation.

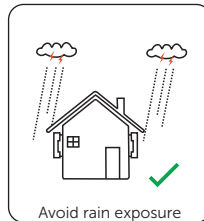
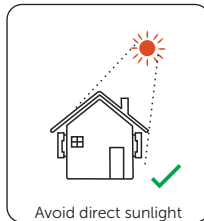
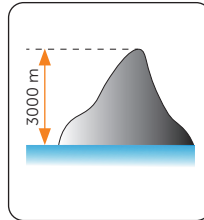
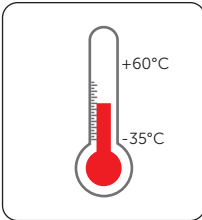

NOTICE!

- For outdoor installation, precautions against direct sunlight, rain exposure and snow accumulation are recommended.
- Exposure to direct sunlight raises the temperature inside the device. This temperature rise poses no safety risks, but may impact the device performance.
- Install the inverter at least 500 meters away from the coast and avoid sea breeze directly hit.

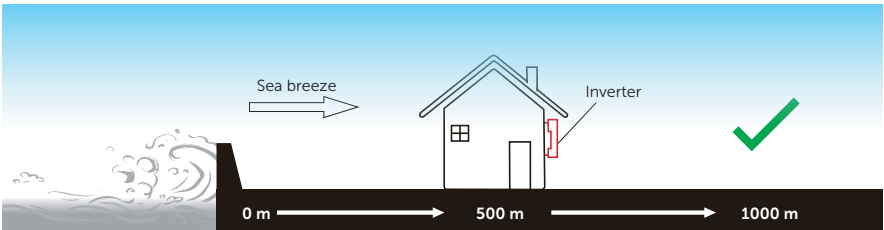

Figure 5-1 No direct see breeze hit

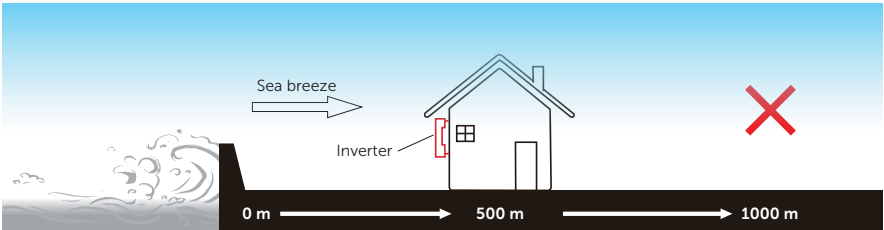

Figure 5-2 Direct see breeze hit

NOTICE!

- For the installation of the whole system, please refer to the specific environment requirement of each unit.

5.1.2 Installation Carrier Requirement

The installation carrier must be made of a non-flammable material, such as solid brick, concrete, etc. and be capable of supporting the weight of the inverter and suitable of the dimensions of the inverter. If the wall strength is not enough (such as wooden wall, the wall covered by a thick layer of decoration), it must be strengthened additionally.

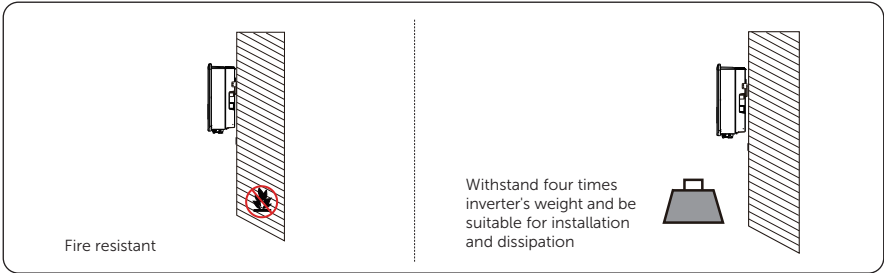

Figure 5-3 Installation carrier requirement

Table 5-2 The weight of inverters

Model	5.0 kW	6.0 kW	8.0 kW	10.0 kW 5.5 kW	12 kW	8.3 kW 15 kW
Weight	30±1 kg					

NOTICE!

- Please take the weight of battery into account when wall-mounting the whole system.

5.1.3 Clearance Requirement

The minimum clearance reserved for the connected terminal at the bottom of inverter should be 120 mm. When planning installation space, it is important to consider the bending radius of the cables.

To guarantee proper heat dissipation and ease of disassembly, the minimum space around the inverter must meet the standards indicated below.

For installations with multiple inverters, make sure to leave a minimum space of 300 mm between left and right inverter and 1000 mm between upper and lower inverter. In areas with high ambient temperatures, increase the clearances between the inverters and provide adequate fresh air ventilation if feasible.

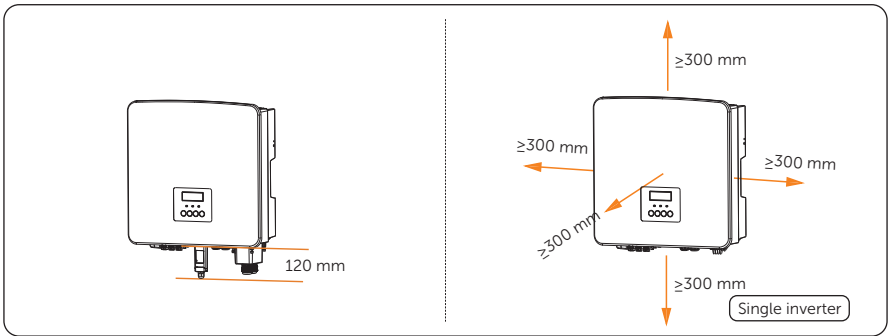

Figure 5-4 Clearance requirement for single inverter

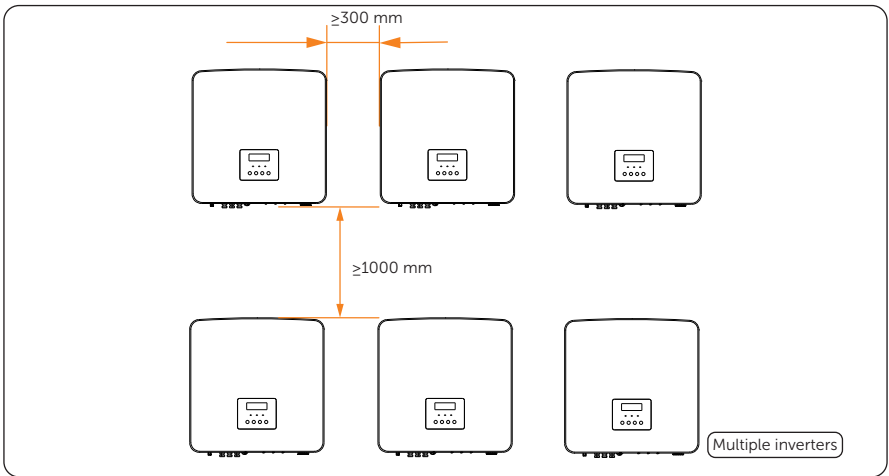

Figure 5-5 Clearance requirement for multiple inverters

5.2 Tools Requirement

Installation tools include but are not limited to the following recommended ones. If necessary, use other auxiliary tools on site. Please note that the tools used must comply with local regulations.

 Hammer drill (drill bit: Ø8 mm)	 Multimeter (≥ 1100 V DC)	 Measuring tape	 Utility knife
 Marker	 Spirit level	 Torque screwdriver (Flat-head: M3) (Phillips head: M2.5 / M4)	 Allen key (including M5)
 Wire stripper	 Crimping tool for RJ45	 Crimping tool for PV terminals	 Diagonal pliers
 Crimping tool	 Crimping tool for ferrules	 Wire cutter	 Rubber mallet
 Torque wrench	 Heat gun	 Heat shrink tubing (Ø6 mm)	
 Safety gloves	 Safety boots	 Safety goggles	 Anti-dust mask

5.3 Additionally Required Materials

Table 5-1 Additionally required wires

No.	Required Material	Type	Conductor Cross-section
1	PV wire	Dedicated PV wire with a voltage rating of 1000 V, a temperature resistance of 105°C, a fire resistance grade of VW-1	4-6 mm ²
2	Communication wire	Network cable CAT5E	/
3	Additional PE wire	Conventional yellow and green wire	4-6 mm ²

Table 5-2 Grid wire and circuit breaker recommended for Grid connection

Model	5.0 kW	6.0 kW	8.0 kW	10.0 kW 5.5 kW	12 kW	8.3 kW 15 kW
Five-core wire (copper)	4-6 mm ²	4-6 mm ²	4-6 mm ²	5-6 mm ²	5-6 mm ²	5-6 mm ²
Circuit breaker	20 A	20 A	32 A	40 A	40 A	40 A

* The diameter of Grid wire should be < Ø 18.

Table 5-3 EPS (off-grid) wire and circuit breaker recommended for EPS connection

Model	5.0 kW	6.0 kW	8.0 kW	10.0 kW 5.5 kW	12 kW	8.3 kW 15 kW
Four-core wire (copper)	4-6 mm ²	4-6 mm ²	4-6 mm ²	4-6 mm ²	4-6 mm ²	4-6 mm ²
Circuit breaker	16 A	16 A	20 A	25 A	32 A	32 A

* The diameter of EPS (off-grid) wire should be < Ø 18.

Table 5-4 Lead-acid battery breaker Recommended

Model	5.0 kW	6.0 kW	8.0 kW	10.0 kW 5.5 kW	12 kW	8.3 kW 15 kW
Voltage	Nominal voltage of DC breaker should be larger than maximum voltage of battery.					
Current	32 A					

* The parameters have some differences because of different environment and material. Please choose appropriate wire and circuit breaker according to the local conditions.

6 Unpacking and Inspection

6.1 Unpacking

- The inverter undergoes 100% testing and inspection before delivery. However, damages may still occur during transportation. Before unpacking, please carefully check the external packaging for any signs of damage, such as punctures or cracks.
- Unpacking the inverter according to the following figure.

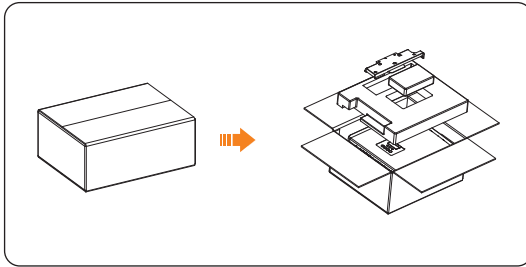

Figure 6-1 Unpacking the inverter

- Properly handle all the packaging materials in case they may be reused for storage and transportation of the inverter in the future.
- Upon opening the package, check whether the inverter is intact and whether all accessories are included. If any damage is found or any parts are missing, contact your dealer immediately.

6.2 Scope of Delivery

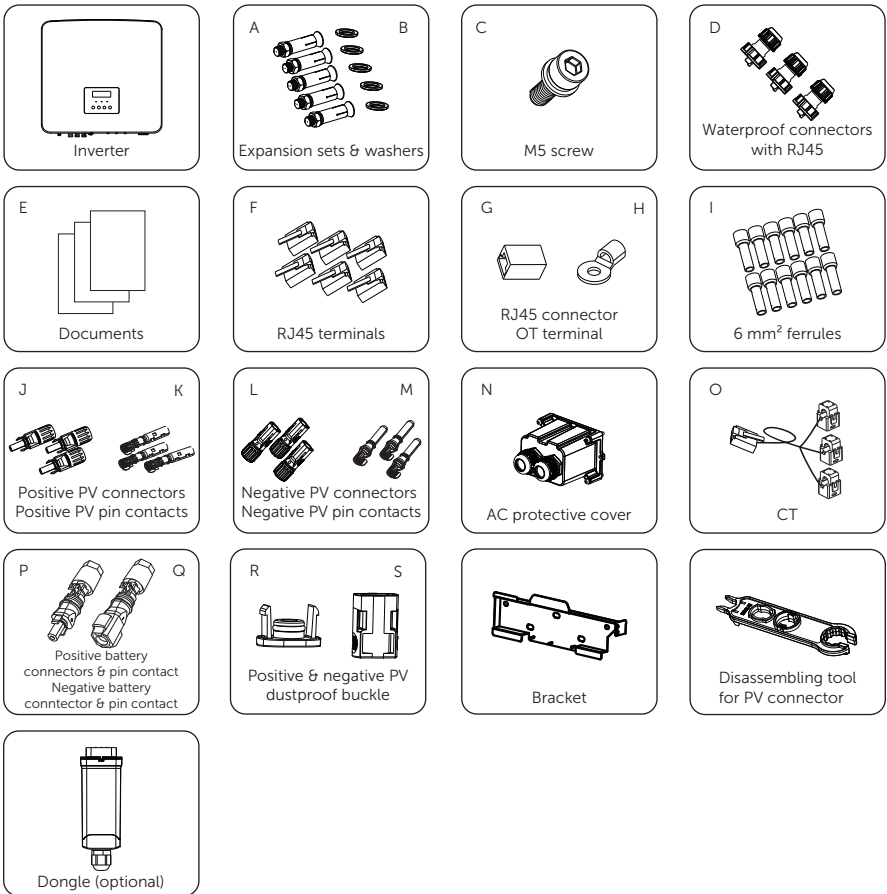

Table 6-1 Packing list

Item	Description	Quantity	Remark
/	Inverter	1 pc	
A	Expansion sets	5 sets	For fixing the bracket
B	Washers	5 pcs	
C	M5 screw	1 pc	For fixing the inverter on the bracket

Item	Description	Quantity	Remark
D	Waterproof connectors with RJ45	3 pairs	For COM, Meter/CT and BMS communication connection
E	Documents	/	
F	RJ45 terminals	6 pcs	
G	RJ45 connector	1 pc	For CT connection
H	OT terminal	1 pc	For grounding
I	6 mm ² ferrules	12 pcs	For Grid and EPS (off-grid) connection
J	Positive PV connectors	2 pairs for 5-6 kW inverters;	
K	Positive PV pin contacts	3 pairs for for 8-15 kW inverters	
L	Negative PV connectors	2 pairs for 5-6kW inverters;	
M	Negative PV pin contacts	3 pairs for for 8-15kW inverters	
N	AC protective cover	1 pc	
O	CT	1 pc	Length: 40 cm
P	Positive battery connector & pin contact	1 pc	
Q	Negative battery connector & pin contact	1 pc	
R	Positive PV dustproof buckle	2 pairs for 5-6 kW inverters;	
S	Negative PV dustproof buckle	3 pairs for for 8-15 kW inverters	
/	Bracket	1 pc	
/	Disassembling tool for PV connector	1 pc	
/	Dongle (Optional)	1 pc	

* Refer to the actual delivery for the optional accessories.

7 Mechanical Installation

! WARNING!

- Only qualified personnel are allowed to perform the mechanical installation in accordance with local laws and regulations.
- Check the existing power cables or other piping in the wall to prevent electric shock or other damage.
- Use insulated tools and wear personal protective equipment throughout the installation and maintenance process.

! CAUTION!

- During installation, always be cautious about the weight of the inverter. Improper lifting or dropping of the inverter may result in personal injury.

NOTICE!

- Install the inverter at a maximum back tilt of 5 degrees and avoid it being forward tilted, side tilted, or upside down.

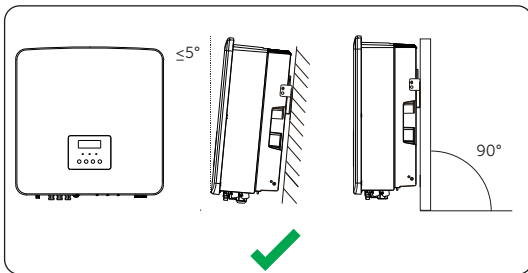

Figure 7-1 Correct installation

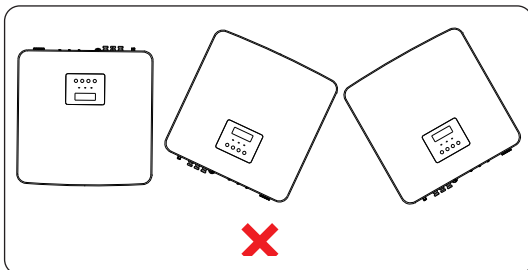

Figure 7-2 Incorrect installation

7.1 Dimensions for Mounting

Before installation, check the dimensions of the bracket and ensure that enough space is reserved for the installation and heat dissipation of the entire system.

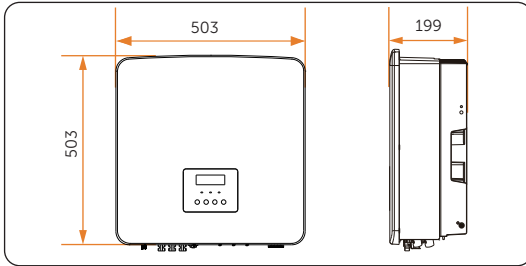

Figure 7-3 Dimensions 1 (Unit: mm)

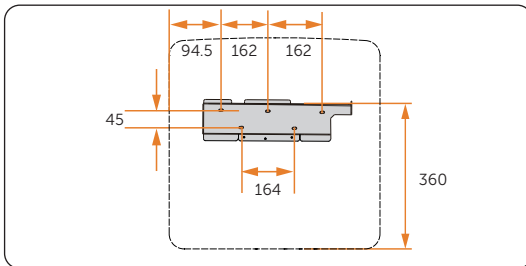

Figure 7-4 Dimensions 2 (Unit: mm)

7.2 Installation Procedures

Step 1: Horizontally align the bracket with the wall, adjust the position of the bracket with a spirit level until the bubble stays in the middle, and then mark holes. (5 holes) Please note that take the height of the battery into account when determining the position of the bracket.

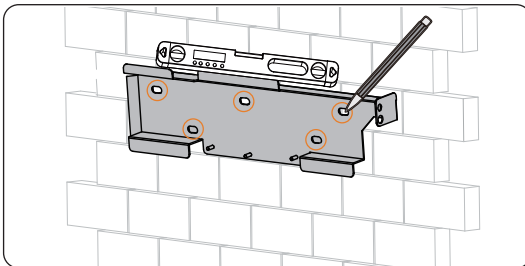

Figure 7-5 Marking the holes

Step 2: Set the bracket aside and drill holes with Ø8 drill bit. The depth of the holes should be 65 mm. Please note that when using a drill, make holes perpendicular to the wall and avoid tilting up or down.

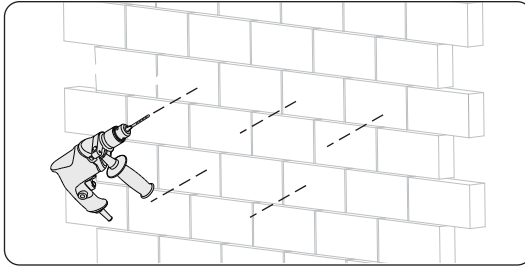

Figure 7-6 Drilling holes

Step 3: Disassemble the nut, spring washer and flat washer from the expansion sets (part A). Knock the expansion bolt with tube into the holes.

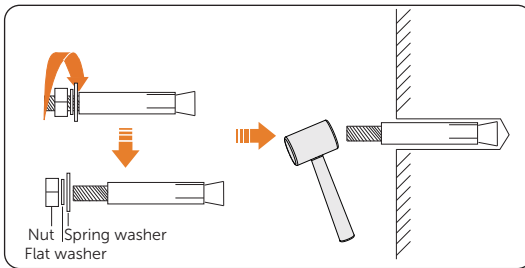

Figure 7-7 Disassembling the expansion set

Step 4: Secure the bracket with nut and washers.

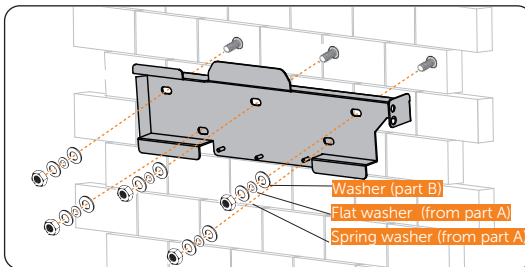

Figure 7-8 Securing the bracket

Step 5: Open the anti-static bag, take out the inverter. If the inverter needs to be temporarily placed on the ground, use foam or other protective materials to protect it against potential damages. Avoid placing the inverter in a way that the wiring terminals are in contact with the floor or any other objects as they are not designed to bear the weight of the inverter.

- Step 6:** Lift up the inverter collaboratively by the required number of personnel in accordance with the local regulation and hang it onto the bracket. Make sure that the hanging slot of the inverter are properly inserted into the lug of the bracket.

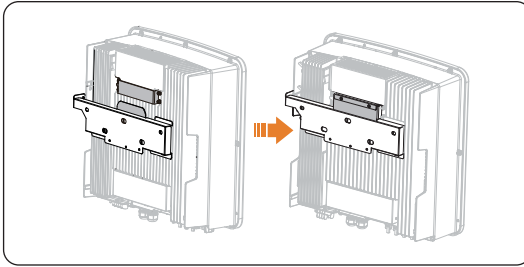

Figure 7-9 Hanging the inverter

- Step 7:** Use M5 screws (part C) to secure the inverter on the bracket.

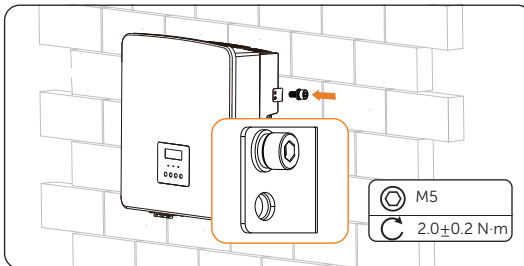

Figure 7-10 Securing the inverter

- Step 8:** (Optional) For safety reason, install an anti-theft lock. The anti-theft lock is not in the scope of delivery. If necessary, prepare a lock with a diameter smaller than $\varnothing 7$ mm by yourself, and keep the key to the lock in a safe place.

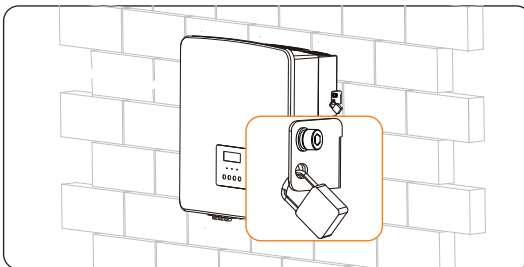

Figure 7-11 Locking the inverter

8 Electrical Connection

DANGER!

- Before electrical connection, make sure the DC switch and AC breaker are disconnected. Otherwise, the high voltage may cause electric shock, resulting in severe personal injuries or even death.

WARNING!

- Only qualified personnel are allowed to perform the electrical connection following local laws and regulations.
- Strictly follow the instructions of this manual or other related documentation for electrical connection. Inverter damages caused by incorrect wiring are not covered by the warranty.
- Use insulated tools and wear personal protective equipment throughout the electrical connection process.

8.1 Overview of Electrical Connection

8.1.1 Terminals and Parts of Inverter

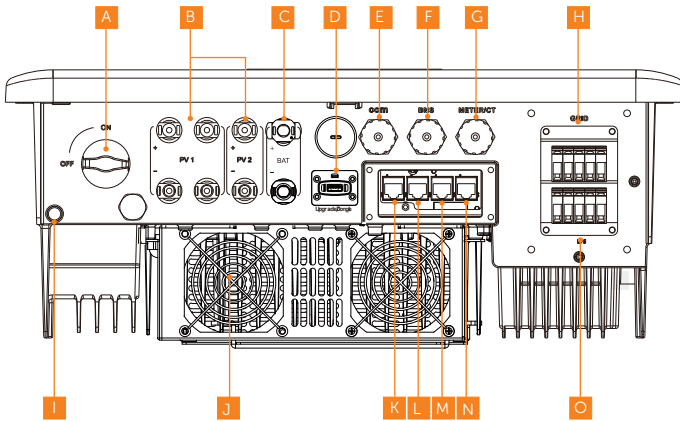

Figure 8-1 Terminals of Inverter

Table 8-1 Description of terminals and parts

Item	Description	Remarks
A	DC switch	
B	PV input terminal	
C	Battery connection terminal	
D	Dongle terminal / Upgrade terminal	
E	COM communication terminal	For communicating with other devices, such as SolaX Adapter Box G2, EV-Charger, etc.
F	Battery communication terminal	
G	Meter/CT communication terminal	
H	Grid connection terminal	
I	Grounding point	
J	Fan	Only for 12 kW and 15 kW inverter
K	CAN1 parallel connection terminal	For parallel connection
L	CAN2 parallel connection terminal	For parallel connection
M	DRM communication terminal	Only applicable to Australia and New Zealand
N	OFF connection terminal	For system switch connection
O	EPS (off-grid) connection terminal	

8.1.2 Cable Connections of Inverter

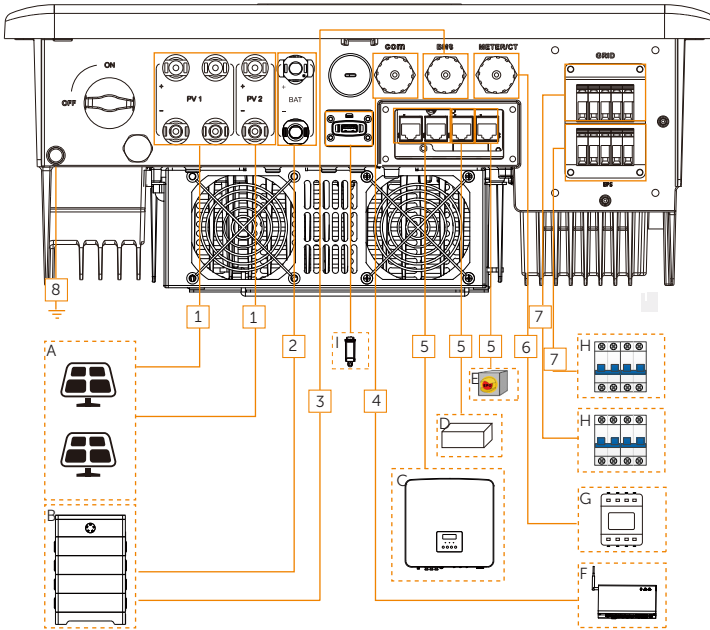

Figure 8-2 Cable connections of inverter

Table 8-2 Descriptions of connected part

Item	Part	Description	Source
A	PV module	A PV string is composed of the PV modules connected in series. The number of input PV strings varies in accordance with different models.	Prepared by user
B	Lithium-ion battery or lead-acid battery	SolaX T-BAT SYS-HV-5.8, T-BAT SYS-HV-3.0, T-BAT-SYS-HV-R2.5, T-BAT-SYS-HV-R3.6, T-BAT-SYS-HV-S2.5 and T-BAT-SYS-HV-S3.6 are supported.	Purchased from SolaX
C	(Optional) X3-Hybrid G4 series inverter	Select a same model of inverter	Purchased from SolaX
D	DRED (only applicable to Australia and New Zealand)	Select the devices that meet the power grid scheduling requirements.	Prepared by user

Item	Part	Description	Source
E	System switch	Select an ON-OFF switch	Prepared by user
	(Optional) SolaX communication device	SolaX DataHub, Adapter Box G2 and EV-Charger, etc are supported. Select the device as needed.	Purchased from SolaX
F	Generator	Select a generator equipped with an Automatic Transfer Switching Equipment (ATS), and the rated output power of the generator should be greater than the sum of the load power and the battery charging power.	Prepared by user
G	Meter/CT	SolaX authorized DTSU666, DTSU666-CT and CT are supported.	Purchased from SolaX
H	Micro circuit breaker (MCB)	Select an appropriate MCB according to the local regulations to ensure the inverter can be securely disconnected from the grid when an emergency occurs. Refer to "5.3 Additionally Required Materials" for the recommended specifications of MCB.	Prepared by user
I	(Optional) Monitoring dongle	Only SolaX monitoring dongle is supported.	Purchased from SolaX

Table 8-3 Descriptions of cables

Item	Cable	Description	Source
1	PV DC input power cable	Refer to "5.3 Additionally Required Materials"	Prepared by user
2	Battery power cable	/	Delivered with battery
3	Battery communication cable		Prepared by user
4	Communication cable		Prepared by user
5	Communication cable	Refer to "5.3 Additionally Required Materials"	Prepared by user
6	Communication cable		Prepared by user
7	AC output cable		Prepared by user
8	PE cable		Prepared by user

8.2 PE Connection

The inverter must be reliably grounded. The PE connection point has been marked with



It is recommended to connect the inverter to a nearby grounding point.



- Do not connect the grounding end of the inverter in series to prevent multi-point grounding.

PE connection procedures

Step 1: Strip off the insulation of the PE cable to an appropriate length.

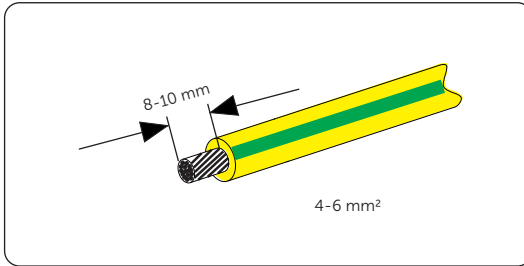

Figure 8-3 Stripping the PE cable

Step 2: Pull the heat-shrink tubing over the PE cable and insert the stripped section into the OT terminal (part H) .

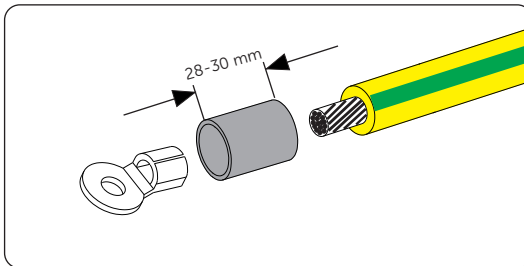

Figure 8-4 Installing the tubing and OT terminal

Step 3: Crimp it with crimping tool, pull the heat-shrink tubing over the stripped section of the OT terminal and use a heat gun to shrink it so that it can be firmly contacted with the terminal.

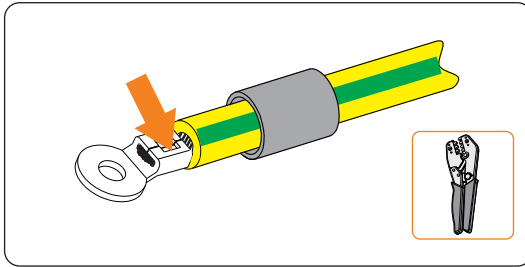

Figure 8-5 Crimping the cable

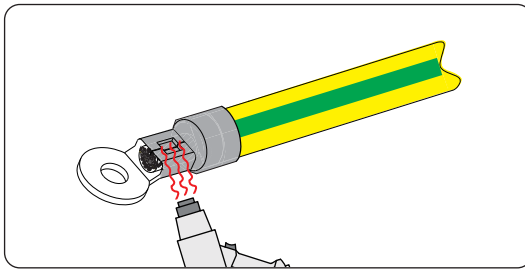

Figure 8-6 Shrinking the tubing

Step 4: Disassemble the PE screw on the inverter with torque wrench. Connect the assembled PE cable to the grounding point of the inverter, and secure it with the original screw. (Torque: 2.0 ± 0.2 N·m)

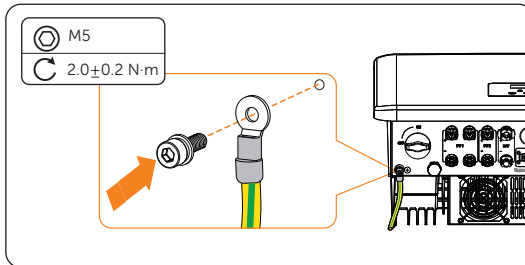

Figure 8-7 Securing the PE cable

8.3 AC Connection

NOTICE!

- Before connecting the inverter to the grid, approval must be received by local utility as required by national and state regulations.

The inverter supports the EPS (off-grid) mode. When connected to the grid, the inverter outputs go through the Grid connection terminal, and when disconnected from the grid, the inverter outputs go through the EPS (off-grid) connection terminal.

Requirements for AC connection

- Grid voltage requirement
 - » The grid voltage and frequency must be within the allowable range (220 V / 127 V for 5.5 kW and 8.3 kW inverter, 415 V / 240 V, 400 V / 230 V, 380 V / 220V for other models, 50 / 60 Hz) and comply with the requirements of the local power grid.
- Residual Current Device (RCD)
 - » The inverter does not require an external RCD when operating. If an external RCD is required by local regulations, a 300 mA Type-A RCD is recommended. If required by local regulations, a Type-B RCD is also permitted.
- AC breaker
 - » An AC breaker that matches the power of the inverter must be used between the inverter output and the power grid. Each inverter must be equipped with an independent breaker or other load disconnection unit to ensure the safe disconnection from the grid. For specific information on the AC breaker for Grid and EPS (off-grid), see ["5.3 Additionally Required Materials"](#).
- EPS (off-grid) load
 - » Make sure that the rated power of the EPS (off-grid) load is within the rated EPS output power range of the inverter. Otherwise, the inverter will report an **EPS Overload Fault** alarm. The inverter will automatically clear the fault when the first and second overload faults occur. When it occurs for the third time, turn off some loads to meet the rated EPS output power range of the inverter, and then press the **ESC** key on the LCD screen to clear the fault.
 - » When connecting to the EPS (off-grid) terminal:

Medical equipment	Connection prohibited
Precision instrument	Connection prohibited
Appliances susceptible to malfunctions in the event of power outages during use	Connection prohibited

- » For inductive loads such as refrigerators, air conditioner, washing machine,

etc., ensure that their start power does not exceed the EPS (off-grid) peak power of the inverter.

Table 8-4 EPS (off-grid) load information

Type of load	Equipment	Start power
Resistive load	Lamp	Rated power
	Fan	Rated power
	Hair dryer	Rated power
	Refrigerator	3-5 times rated power
Inductive load	Air conditioner	3-6 times rated power
	Washing machine	3-5 times rated power
	Microwave oven	3-5 times rated power

* Refer to the nominal start power of the equipment for the actual start power. The EPS (off-grid) terminal of the inverter does not support a half-wave load to be connected.

Wiring procedures

Step 1: Prepare Grid cable and EPS (off-grid) cable (see "5.3 Additionally Required Materials" for cable requirement) and strip off the insulation of the conductor to an appropriate length.

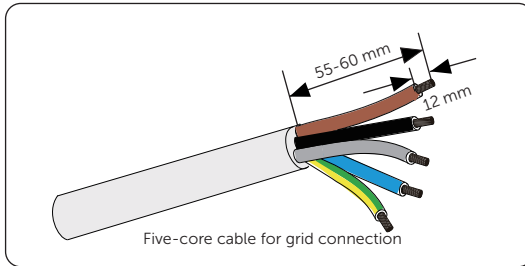

Figure 8-8 Stripping the Grid cable

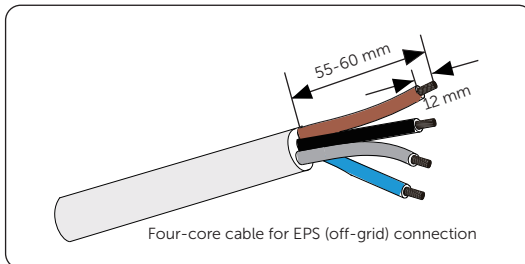

Figure 8-9 Stripping the EPS (off-grid) cable

Step 2: Disassemble the AC protective cover (part N) as shown below. Remove the sealing plug. Please note that keep the sealing plug in the hole if it is not in use.

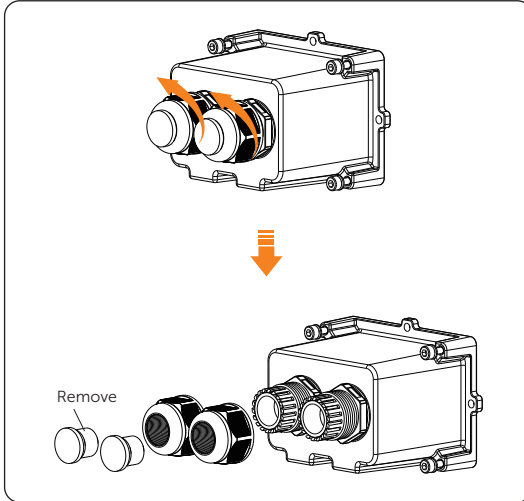

Figure 8-10 Disassembling the AC protective cover

Step 3: Thread the Grid and EPS (off-grid) cable through the swivel nut and the AC protective cover enclosure in sequence.

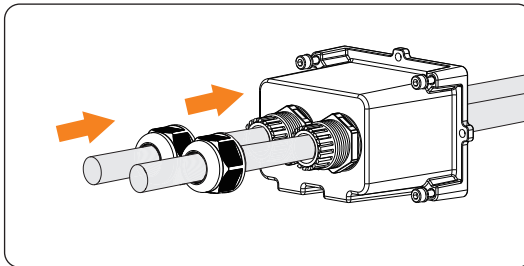

Figure 8-11 Threading the grid cable

Step 4: Insert the conductors L1, L2, L3, N, and the grounding conductor of Grid cable and the conductors L1, L2, L3, N of EPS (off-grid) cable into the ferrules (part I). Use a crimping tool for ferrules to crimp it. Make sure the conductors are correctly assigned and firmly seated in the ferrules.

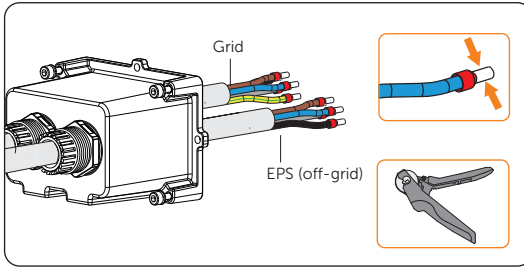

Figure 8-12 Crimping the conductors

Step 5: Remove the dustproof cover from the inverter.

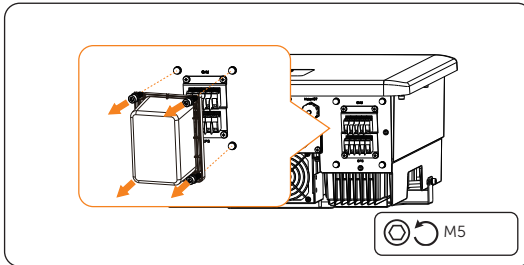

Figure 8-13 Removing the dustproof cover

Step 6: Insert the crimped conductors into the AC terminal according to the labeling and tighten the terminal screws (torque: 0.7 ± 0.1 N·m). Install the AC protective cover, and lock the cover with torque wrench. (Torque: 2.0 ± 0.2 N·m)

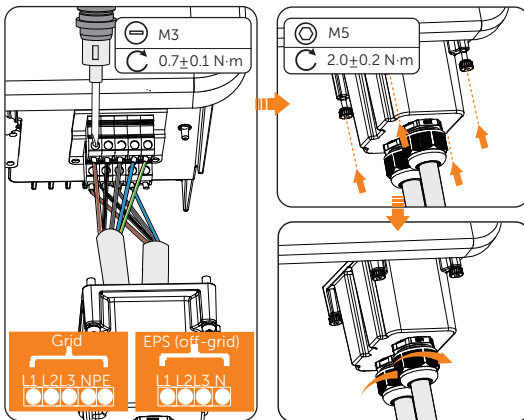

Figure 8-14 Installing the AC protective cover

 **DANGER!**

- Before powering on the inverter, make sure the AC protective cover has been installed correctly on the AC terminal even if the terminal is not wired. Otherwise, electrical shock may be caused by high voltage, resulting in serious personal injury or death.

8.4 PV Connection

 **DANGER!**

- When exposed to the sunlight, PV modules will generate lethal high voltage. Please take precautions.
- Before connecting the PV modules, make sure that both DC switch and AC breaker are disconnected, and that the PV module output is securely isolated from the ground.

 **WARNING!**

- To mitigate the risk of fire, it is crucial to utilize a dedicated crimping tool specifically designed for PV installations to ensure secure and reliable connections.

 **CAUTION!**

- Power is fed from more than one source and more than one live circuit.

NOTICE!

- DC isolator complied with AS 609473: 2018 and local regulation shall be installed for PV input connection for the inverters of models without DC isolator fitted inside the enclosure.
- If the PV is grounded, the inverter will turn on a red light and report **IsolationFault**. This inverter complies with IEC 62109-2 clause 13.9 for earth fault alarm monitoring.

Requirements for PV connection

- Open circuit voltage and operating voltage
 - » The open circuit voltage of each module array cannot exceed the maximum PV input voltage (800 V for 5.5 kW and 8.3 kW inverters; 1000 V for other models) of the inverter. Otherwise, the inverter may be damaged.
 - » The operating voltage of PV modules must be within the MPPT voltage range (160-650 V for 5.5 kW and 8.3 kW inverters; 180-950 V for other models) Otherwise, the inverter will prompt a **PV Volt Fault** alarm. Consider

the impact of low temperature on the voltage of the photovoltaic panels, as lower temperatures tend to result in higher voltages.

- PV module
 - » The PV modules within the same MPPT channel are of the same brand. Additionally, the strings within the same channel should have identical quantities, and be aligned and tilted identically.
 - » The positive or negative pole of the PV modules should not be grounded.
 - » The positive cables of the PV modules must be connected with positive DC connectors.
 - » The negative cables of the PV modules must be connected with negative DC connectors.
 - » **Multi** PV module connection mode:

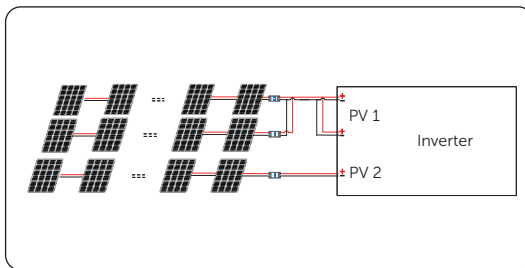

Figure 8-15 **Multi** mode

Wiring procedures

Step 1: Strip off the insulation of the PV cables to an appropriate length.

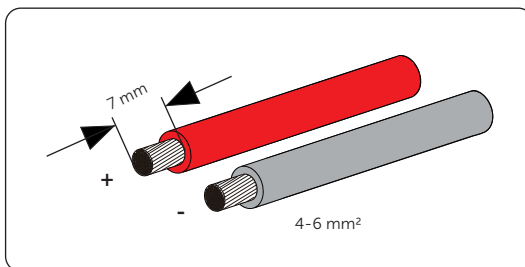

Figure 8-16 Stripping the PV cable

Step 2: Insert the stripped cable into the PV pin contact (part K and M).

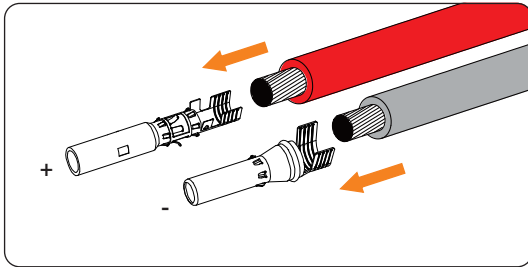

Figure 8-17 Inserting the PV pin contact

Step 3: Make sure the the PV cable and PV pin contact are of the same polarity. Crimp it with crimping tool for PV terminal. Pay attention to the crimping position.

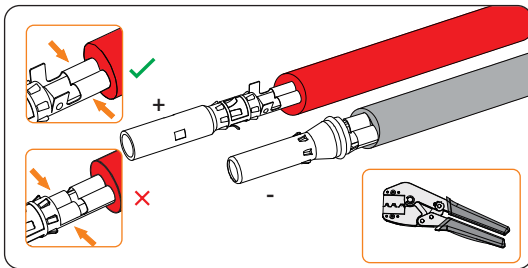

Figure 8-18 Crimping the terminal

Step 4: Thread the PV cable through swivel nut and insert the cable into the PV connector (part J and L).

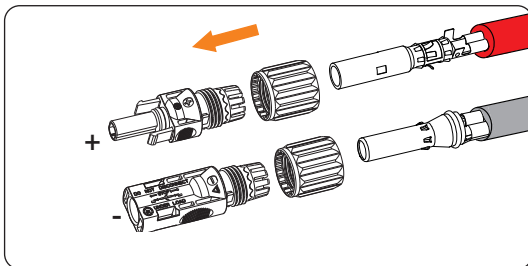

Figure 8-19 Threading the PV cable

Step 5: A "Click" will be heard if it is connected correctly. Gently pull the cable backward to ensure firm connection. Tighten the swivel nut clockwise. Verify that the PV connectors have the correct polarity before connection.

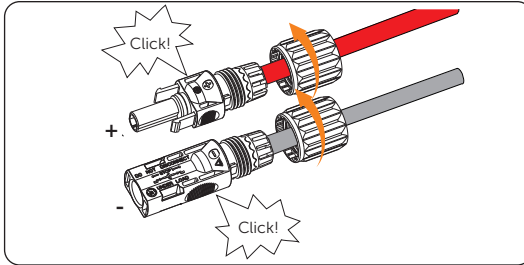

Figure 8-20 Securing the PV cable

Step 6: Use a voltage measuring device which complies with the local regulation to measure the positive and negative voltage of the assembled PV connectors. Make sure the open circuit voltage does not exceed the MPPT voltage range of the inverter. (650 V for 5.5 kW and 8.3 kW inverter; 950 V for other models)

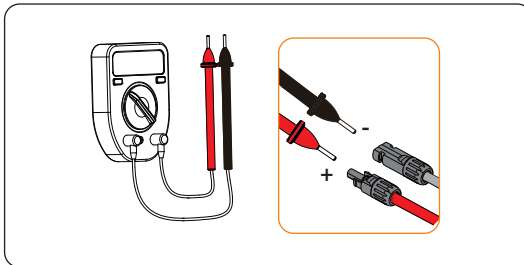

Figure 8-21 Measuring the voltage of PV connectors

NOTICE!

- If the voltage reading is negative, it indicates an incorrect DC input polarity. Please check if the wiring connections on the measuring device are correct or PV connectors are not mistakenly connected.

Step 7: Remove the PV terminal caps and connect the assembled PV connectors to the corresponding terminals until there is an audible "Click". The PV+ on the string side must be connected to the PV+ on the inverter side, and the PV- on the string side must be connected to the PV- on the inverter side.

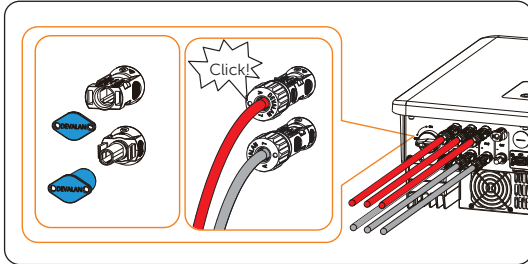

Figure 8-22 Connecting the PV cable

Step 8: Seal the unused PV terminal with positive and negative dustproof buckle. (Part R and S).

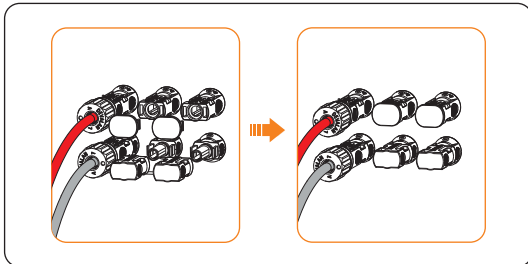

Figure 8-23 Installing the dustproof buckles

8.5 Battery Power Cable Connection

⚠ DANGER!

- Before connecting the cables, make sure the breaker, power button (if any) and DC switch (if any) of battery is OFF.
- Always ensure correct polarity. Never reverse the polarity of the battery cables as this will result in inverter damage.

NOTICE!

- The power cable of battery is in the battery accessory pack. NOT in the scope of inverter's delivery. If the power cable of battery is prepared by yourself, an 8 mm² power cable that is less than 3 m long is suggested.

Requirments for battery connection

- Battery
 - » SolaX lithium-ion battery or lead-acid battery
 - » Max charge and discharge current is 30 A.
 - » Make sure the input voltage of BAT terminal is higher than minimum voltage 120 V (180 V for 5.5 kW and 8.3 kW inverter) and lower than maximum input voltage 800 V (650 V for 5.5 kW and 8.3 kW inverter).
- Micro circuit breaker (MCB)
 - » If the battery is integrated with a readily accessible internal DC breaker, no additional DC breaker is required. If local regulations mandate the use of a DC MCB between the battery and the inverter, install a non-polar DC MCB.
 - » The nominal voltage of DC MCB should be larger than maximum voltage of battery.
 - » See documentations of battery for more details.
- Battery configuration information

Table 8-5 Battery configuration information

Supported battery model	Battery control	Battery pack
T-BAT SYS-HV-5.8	T-BAT 5.8 (1 pc)	HV11550 (1~3 pcs)*
T-BAT SYS-HV-3.0	MC0600 (1 pc)	HV10230 (2~4 pcs)
T-BAT-SYS-HV-R2.5	TBMS-MCR0800 (1 pc)	TP-HR25 (4~13 pcs)**
T-BAT-SYS-HV-R3.6	TBMS-MCR0800 (1 pc)	TP-HR36 (4~13 pcs)**
T-BAT-SYS-HV-S2.5	TBMS-MCS0800 (1 pc)	TP-HS25 (3~13 pcs)***
T-BAT-SYS-HV-S3.6	TBMS-MCS0800 (1 pc)	TP-HS36 (3~13 pcs)***

* HV11550 battery packs have V1 and V2 versions, V1 and V2 with the same number of inverters, the specific collocation refers to the relevant part of the battery manual.

** For X3-Hybrid-5.5-D LV and X3-Hybrid-8.3-D LV inverters, only 4~12 pieces of battery packs (TP-HR25 / TP-HR36) and one piece of battery control (TBMS-MCR0800) can be installed together with an inverter.

*** For X3-Hybrid-5.5-D LV and X3-Hybrid-8.3-D LV inverters, only 4~12 pieces of battery packs (TP-HS25 / TP-HS36) and one piece of battery control (TBMS-MCS0800) can be installed together with an inverter.

For T-BAT-SYS-HV-S2.5 and T-BAT-SYS-HV-S3.6, three pieces of battery packs with one piece of battery control is the minimum quantity to be installed with an inverter. If there is no PV input and the total voltage of the system with three battery packs is at a minimum of 127 V, the system will not operate.

Wiring procedures

Step 1: Strip off the insulation of the battery power cable to an appropriate length.

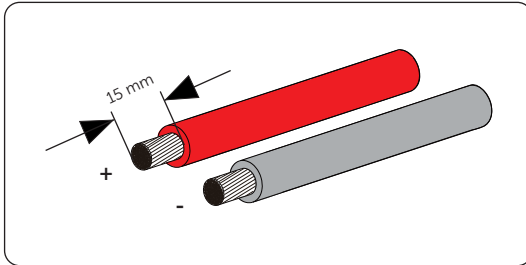

Figure 8-24 Stripping the battery cable

Step 2: Insert the stripped end of the battery cables into the positive and negative battery connectors respectively (part P and Q). And ensure the cables are in the right place of the connectors.

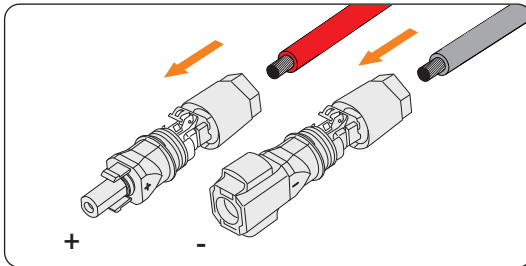

Figure 8-25 Inserting the battery connector

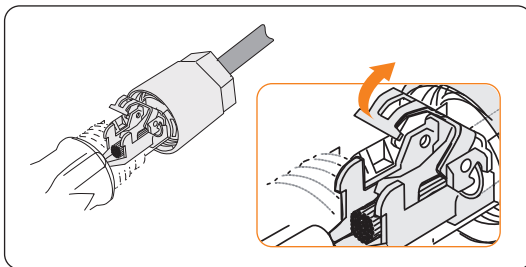

Figure 8-26 The right place of connector

- Step 3:** Press down the spring by hand. A "Click" will be heard if it is connected correctly. Make sure that the spring is snapped in.

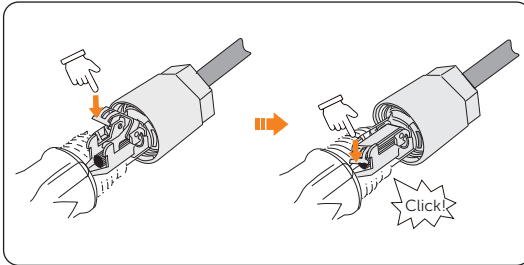

Figure 8-27 Pressing down the spring

- Step 4:** Push the connector into the sleeve and tighten the cable gland.

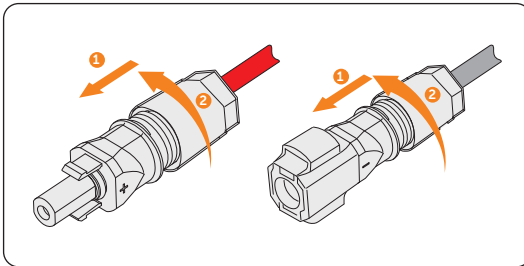

Figure 8-28 Tightening the cable gland

- Step 5:** Remove the battery terminal caps and connect the assembled battery connectors to the corresponding terminals until there is an audible "Click".

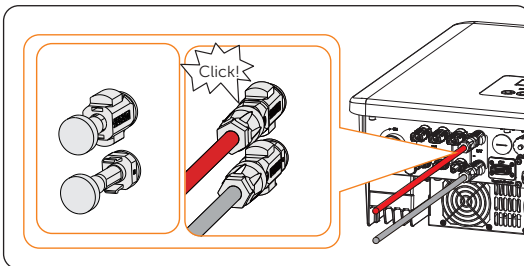

Figure 8-29 Connecting the battery connector

⚠ CAUTION!

- Keep the terminal caps in a safe place if batteries are connected to the inverter. Reinstall the caps immediately after removing the connectors from the terminals.

8.6 Communication Connection

The communication connections are located in the COM, BMS, Meter/CT, CAN1, CAN2, DRM, and OFF communication terminals. The diagram of the completed communication connection is shown below:

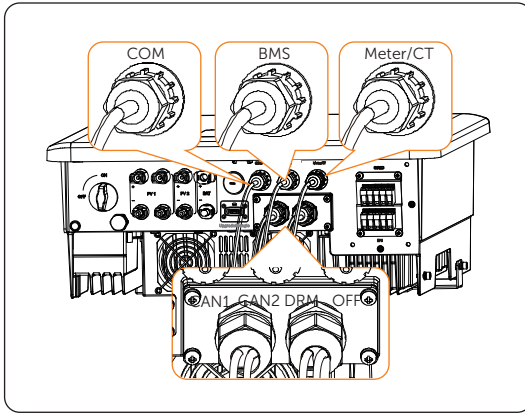

Figure 8-30 The completed communication connection

8.6.1 COM Communication Connection

The COM terminal is mainly used for communication between the inverter and other external devices, such as generator, SolaX Adapter Box G2, EV-Charger, DataHub, etc. The communication protocol is Modbus RTU. For detailed applications of the generator, Adapter Box G2, AC EV-Charger, and DataHub, see "15 Appendix".

NOTICE!

- The cable length for COM communication connection shall not exceed 30 meters.

Pin assignment of COM terminal

Table 8-6 Pin assignment of COM terminal

Pin	Pin assignment	Description
1	Drycontact_A(in)	For system switch connection
2	Drycontact_B(in)	
3	+13V	

Pin	Pin assignment	Description
4	485A	For other devices connection, such as SolaX Adapter Box G2, EV-Charger, DataHub, etc.
5	485B	
6	GND	For generator connection
7	Drycontact_A(out)	
8	Drycontact_B(out)	

* Pin 3 (+13V) and Pin 6 (GND) cannot be connected together in the process of cable connection. Please wrap the two pins with insulating tape if the two pins do not need to be connected.

Wiring procedure

Step 1: Prepare a CAT5E network cable, thread the network cable through waterproof connector (part D) and strip off the 15 mm insulation of the cable.

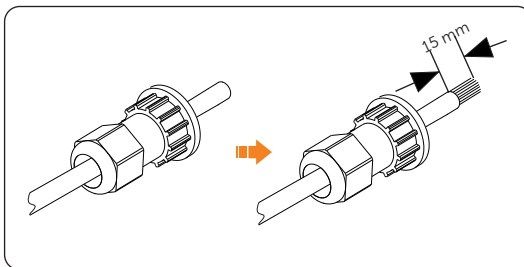

Figure 8-31 Stripping the insulation

Step 2: Insert the stripped section into the RJ45 terminal (from part D). Crimp it tightly with a crimping tool for RJ45. Pay attention to the pin order of RJ45 terminal. Use a network cable tester to check if the cable has been correctly and properly crimped before connecting to inverter.

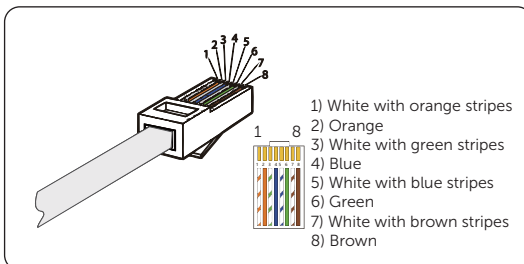

Figure 8-32 Crimping the network cable

Step 3: Install the network cable of the crimped RJ45 terminals to COM terminal according to the labeling.

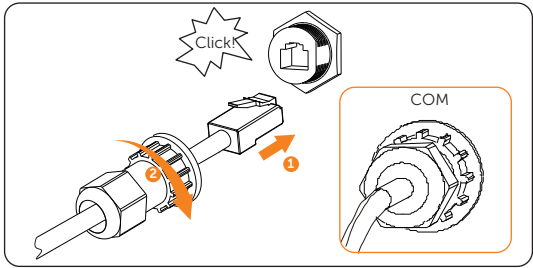

Figure 8-33 Connecting to COM terminal

8.6.2 BMS Communication Connection

The BMS communication terminal is mainly used for communication between the inverter and the battery. The battery can work normally only after the battery power cable and communication cable are connected.

NOTICE!

- The cable length for BMS communication connection shall not exceed 3 meters.

Battery connection diagram (take T-BAT-SYS-HV-S2.5 as an example)

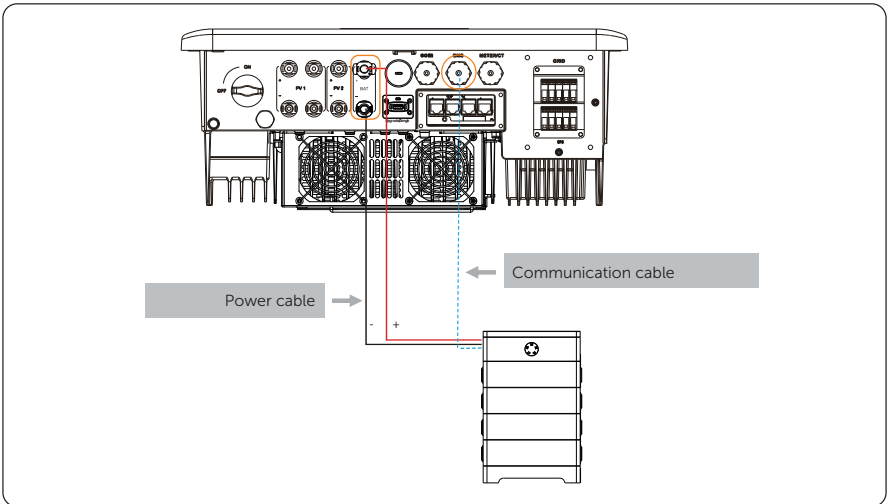

Figure 8-34 Battery connection diagram

Table 8-7 Pin assignment of BMS terminal

Pin	Pin assignment
1	EXT_NTC
2	GND
3	GND
4	BMS_CANH
5	BMS_CANL
6	X
7	BMS_485A
8	BMS_485B

* The pin assignment of communication terminal on the battery must be consistent with the assignment of Pin 4, 5, 7 and 8 above.

Wiring procedure

Step 1: Prepare a CAT5E network cable, thread the network cable through waterproof connector (part D) and strip off the 15 mm insulation of the cable.

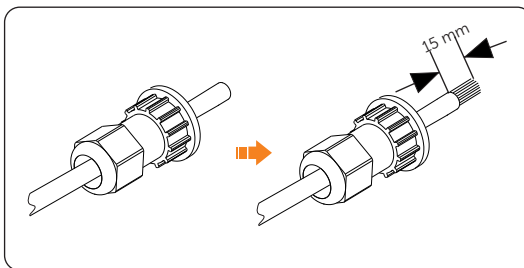

Figure 8-35 Stripping the insulation

Step 2: Insert the stripped section into the RJ45 terminals (from part D). Crimp it tightly with a crimping tool for RJ45. Pay attention to the pin order of RJ45 terminals. Use a network cable tester to check if the cable has been correctly and properly crimped before connecting to inverter.

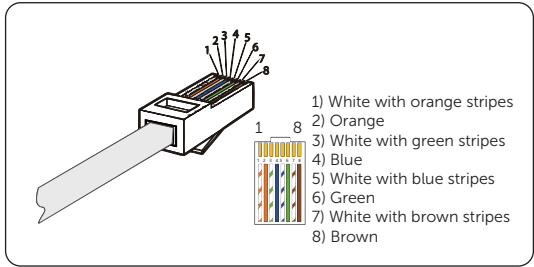

Figure 8-36 Crimping the network cable

Step 3: Install the network cable of the crimped RJ45 terminal to BMS terminal according to the labeling.

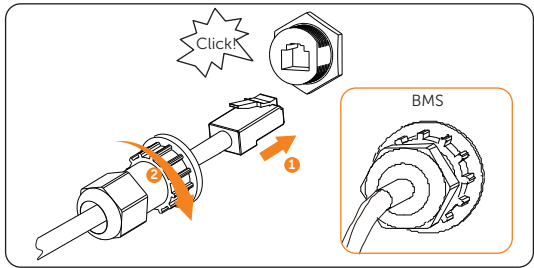

Figure 8-37 Connecting to BMS terminal

8.6.3 Meter/CT Connection

The inverter should work with an electric meter or current transformer (CT for short) to monitor household electricity usage. The electricity meter or CT can transmit the relevant electricity data to the inverter or platform.

CAUTION!

- Smart meters must be authorized by our company. Unauthorized meter may be incompatible with the inverter, thereby resulting in inverter damage and working mode malfunction. SolaX will not be responsible for the impact caused by the use of other appliances.

NOTICE!

- For detailed meter/CT connection, see "15.6 Meter/CT Connection Scenarios".

Pin assignment of COM terminal

Table 8-8 Pin assignment of Meter/CT terminal

Pin	Pin assignment	Description
1	CT_R_1	
2	CT_S_1	For CT connection
3	CT_T_1	
4	485A	
5	485B	For meter connection
6	CT_R_1	
7	CT_S_1	For CT connection
8	CT_T_1	

Meter wiring procedure

Step 1: Take out the network cable from the meter box, thread the network cable through waterproof connector (part D) and strip off the 15 mm insulation of the cable.

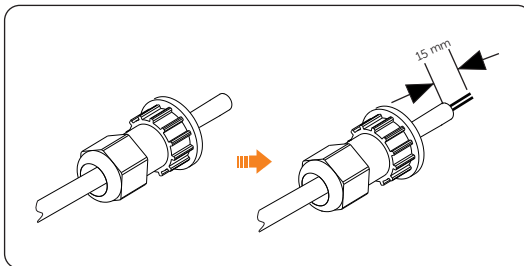

Figure 8-38 Stripping the insulation

Step 2: Insert the stripped section into the Pin 4 and Pin 5 of RJ45 terminal (from meter box). Crimp it tightly with a crimping tool for RJ45. Pay attention to the pin order of RJ45 terminals. Use a network cable tester to check if the cable has been correctly and properly crimped before connecting to inverter.

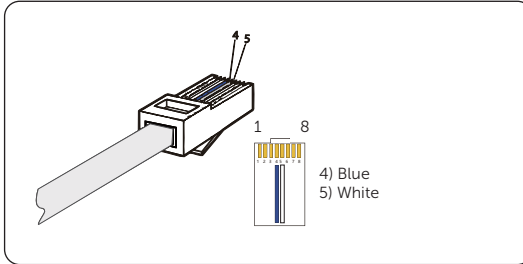

Figure 8-39 Crimping the network cable

Step 3: Install the network cable of the crimped RJ45 terminal to Meter/CT terminal according to the labeling.

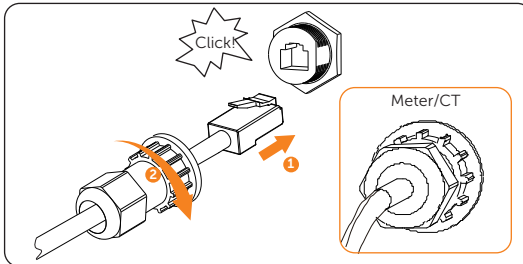

Figure 8-40 Connecting to inverter Meter/CT terminal

Step 4: Strip off the 10-15 mm insulation for the other end of the network cable and install it to meter terminal 24 and 25.

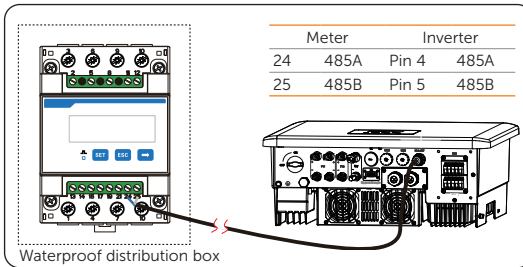

Figure 8-41 Connecting to Meter

CT wiring procedure

Step 1: Prepare a CAT5E network cable, thread the network cable through waterproof connector (part D) and strip off the 15 mm insulation for two ends of the network cable.

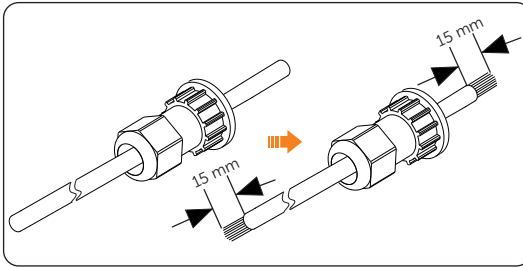

Figure 8-42 Stripping the insulation

Step 2: Insert the stripped section into the RJ45 terminals (from part D and part F). Crimp it tightly with a crimping tool for RJ45. Pay attention to the pin order of RJ45 terminals. Use a network cable tester to check if the cable has been correctly and properly crimped before connecting to inverter.

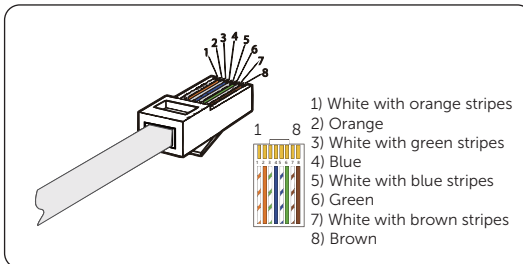

Figure 8-43 Crimping the network cable

Step 3: Install the network cable of the crimped RJ45 terminal to Meter/CT terminal according to the labeling.

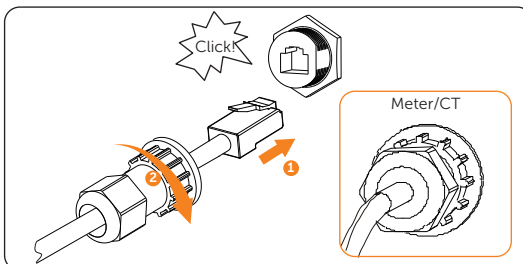

Figure 8-44 Connecting to inverter Meter/CT terminal

Step 4: Install the other end of network cables to RJ45 connector (part G) and insert the CT (part O) to RJ45 connector.

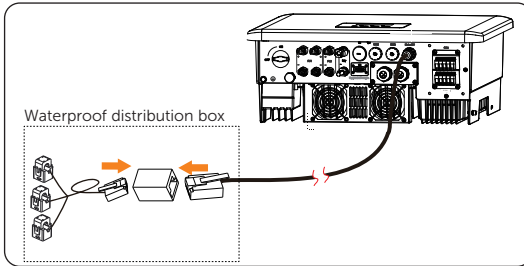

Figure 8-45 Connecting to CT

8.6.4 CAN1 / CAN2 / DRM / OFF Communication Connection

CAN1 / CAN2 communication connection

The inverter provides the parallel connection function. One inverter will be set as the Master inverter to control the other Slave inverters in the system. For details, please refer to "15.5 Application of Parallel Function".

NOTICE!

- The communication cables between the CAN1 and CAN2 terminals of different inverters in parallel connection and between the COM terminal of the X3-PBOX series device and the CAN1 terminal of the Master inverter is no more than 3 meters.

Table 8-9 Pin assignment of CAN1/CAN2

CAN1	Pin assignment	CAN2	Pin assignment
1	485A	1	485A
2	485B	2	485B
3	VCC	3	X
4	CANH	4	CANH
5	CANL	5	CANL
6	GND	6	GND
7	SYN1	7	SYN1
8	SYN2	8	SYN2

DRM communication connection (Applicable to AS/NZS 4777.2)

According to AS/NZS 4777.2, the inverter needs to support the function of demand response mode (DRM). With the use of an external control box, active or reactive power regulation can be realized in a timely and fast manner, and the inverter can be operated stably during the process of regulation.

DRM 0, DRM 1 and DRM 5 are available now.

Pin assignment of DRM

Table 8-10 Pin assignment of DRM

Pin	Pin assignment
1	DRM1/5
2	DRM2/6
3	DRM3/7
4	DRM4/8
5	+3.3V
6	DRM0
7	GND
8	GND

DRED connection diagram

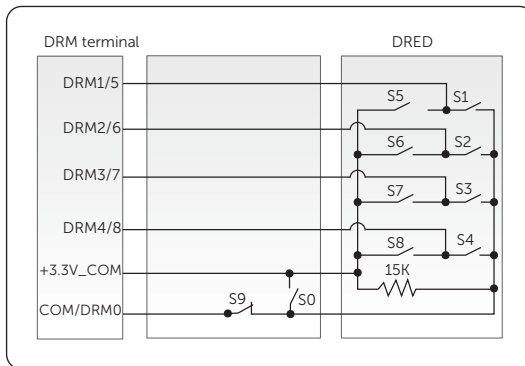

Figure 8-46 DRED connection diagram

Table 8-11 Descriptions of DRM

Mode	Pin	Requirement
DRM 0	Pin 6	<ul style="list-style-type: none"> When S0 is turned on, the inverters shut down. When S0 is turned off, the inverters restore grid connection.

Mode	Pin	Requirement
DRM 1	Pin 1	• When S1 is turned on, the inverters do not input active power.
DRM 5	Pin 1	• When S5 is turned on, the inverters do not output active power.

OFF communication connection

OFF terminal is designed to support system switch connection.

To enhance safety and reduce the risk of injury, you can install the system switch in a readily accessible location. In the event of an emergency, the system switch can be easily reached and pressed to promptly switch off the entire system, ensuring a swift response and preventing further harm.

Table 8-12 Pin assignment of OFF

Pin	Pin assignment
1	X
2	X
3	X
4	shutdown
5	X
6	+3.3V
7	X
8	X

* If Pin 4 and Pin 6 are connected together, the inverter will be off.

CAN1 / CAN2 / DRM / OFF wiring procedure

Step 1: Loosen the cross screws and disassemble the cover from the inverter.

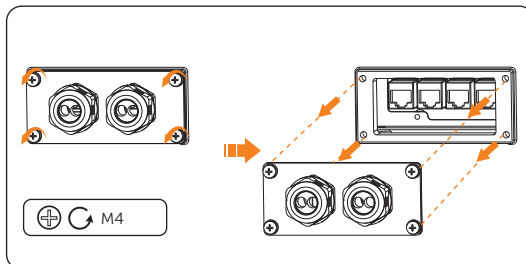

Figure 8-47 Disassembling the cover

Step 2: Loosen the swivel nut on the cover, and then remove the sealing plugs from the holes as needed. Keep the sealing plugs in the hole if it is not in use.

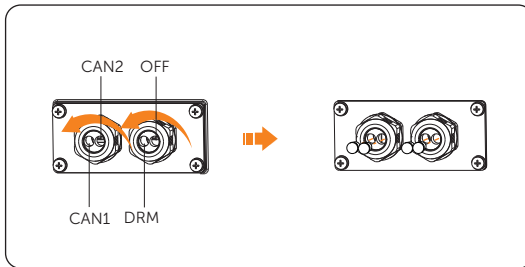

Figure 8-48 Removing the sealing plugs

Step 3: Thread the network cables through the swivel nut and cover in sequence and strip off approx. 15 mm of the cable insulation.

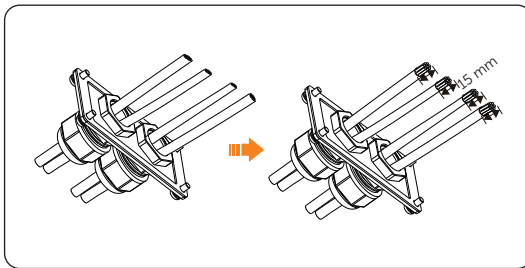

Figure 8-49 Threading and stripping the cable

Step 4: Insert the stripped section into the RJ45 terminals (part F). Crimp it tightly with a crimping tool for RJ45. Pay attention to the pin order of RJ45 terminals. Use a network cable tester to check if the cable has been correctly and properly crimped before connecting to inverter.

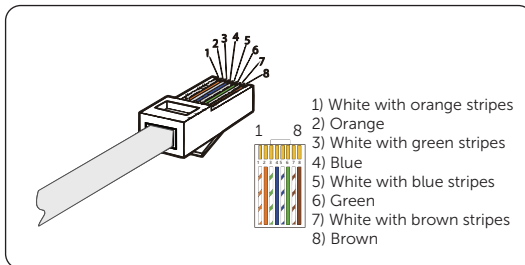

Figure 8-50 Crimping the communication cable

Step 5: Install the network cables of the crimped RJ45 terminals to CAN1, CAN2, DRM

and OFF terminal according to the labeling. An audible "Click" will be heard if they are connected correctly.

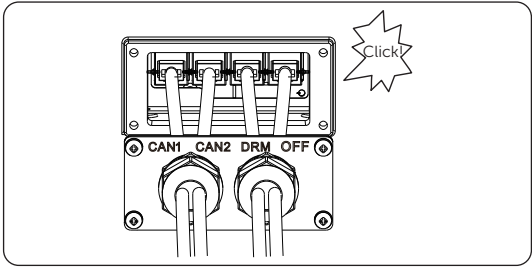

Figure 8-51 Connecting to the inverter

Step 6: Tighten the screws and lock the cover on the inverter. And then tighten the swivel nuts.

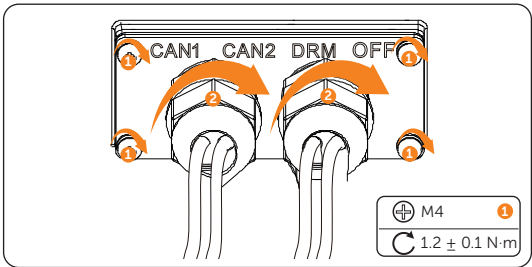

Figure 8-52 Securing the cables

8.7 Monitoring Connection

The inverter provides a **Upgrade/Dongle** terminal, which can transmit data of the inverter to the monitoring website via WiFi+LAN dongle (Optional). The WiFi+LAN dongle is equipped with two kinds of communication modes (Wi-Fi mode or LAN mode). Users can choose based on actual needs. (If needed, purchase products from us.)

Monitoring connection diagram

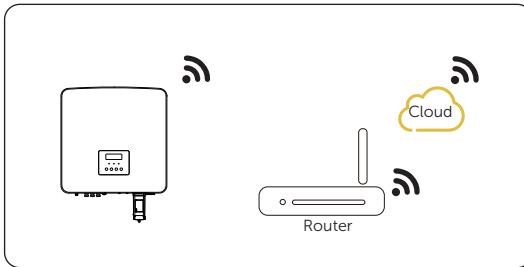

Figure 8-53 Wi-Fi mode connection diagram

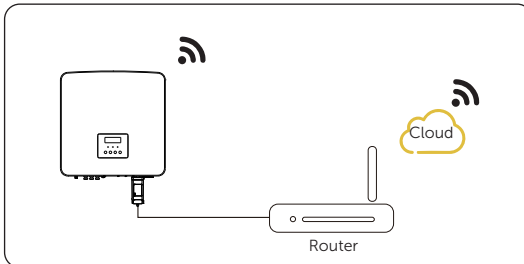

Figure 8-54 LAN mode connection diagram

Monitoring wiring procedure

Wi-Fi mode:

- a. Assemble the dongle.

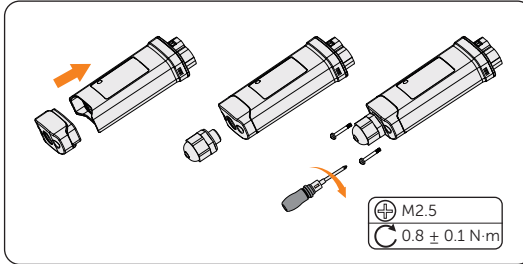

Figure 8-55 Assembling the dongle

- b. Plug the dongle to the inverter.

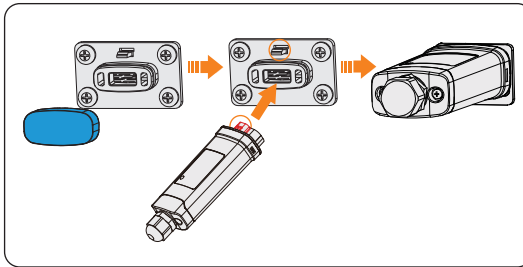

Figure 8-56 Connecting to the inverter

CAUTION!

- The buckles on the inverter and dongle must be on the same side. Otherwise, the dongle may be damaged.

NOTICE!

- The distance between the router and the inverter must be no more than 100 meters. If there are walls in between, the distance must be no more than 20 meters.
- For locations where Wi-Fi signals are weak, install a Wi-Fi signal booster.

NOTICE!

- For details on Wi-Fi configuration, see Pocket WiFi + LAN installation manual. You can configure Wi-Fi only after the inverter is powered on.

LAN mode:

- a. Disassemble the waterproof connector into components 1, 2, 3 and 4; Component 1 is not used. Keep it in a safe place.

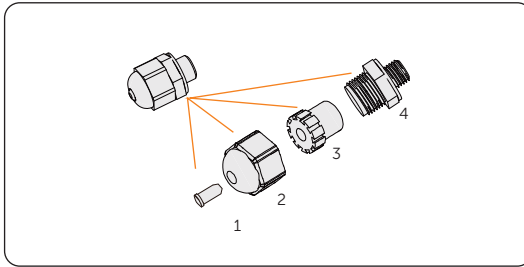

Figure 8-57 Disassembling the waterproof connector

- b. Assemble the dongle.

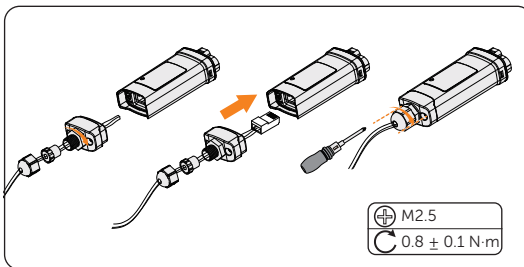

Figure 8-58 Assembling the dongle

- c. Plug the dongle to the inverter.

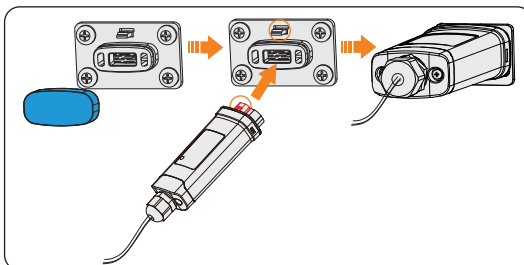

Figure 8-59 Connecting to the inverter

9 System Commissioning

9.1 Checking before Power-on

No.	Item	Checking details
1	Installation	The inverter is installed correctly and securely. The battery is installed correctly and securely. Other device (if any) is installed correctly and securely.
2	Wiring	All DC, AC cables and communication cables are connected correctly and securely; The meter/CT is connected correctly and securely. The ground cable is connected correctly and securely;
3	Breaker	All the DC breakers and AC breakers are disconnected;
4	Connector	The external AC and DC connectors are connected; The AC protective cover on the Grid and EPS (off-grid) terminal is connected correctly and securely.
5	Unused terminal	Unused terminals and ports are locked by waterproof caps. Unused PV terminals are locked by dustproof buckles.
6	Screw	All the screws are tightened.

9.2 Powering on the System

Step 1: Turn on the DC switch and check the LCD screen.

- » If the LCD screen is not on, turn off the DC switch and check whether the PV polarity is connected correctly.
- » If the error of any channel of PV is displayed on LCD, turn off the DC switch and check the corresponding channel of PV connection.

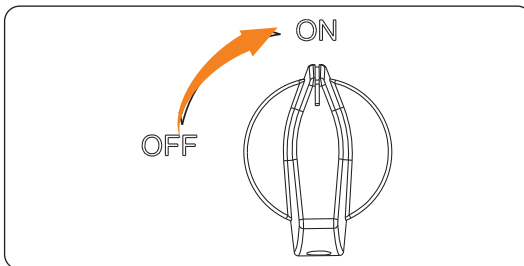

Figure 9-1 Turning on the DC switch

Step 2: Switch on the AC breaker and wait for the inverter power on.

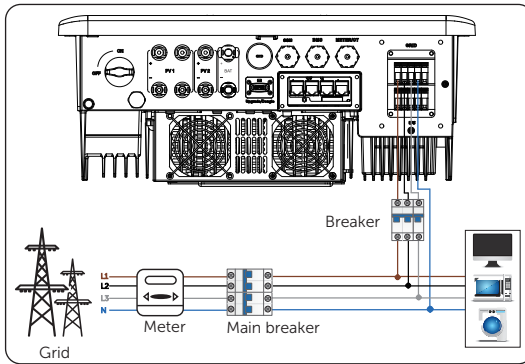

Figure 9-2 Switching on the AC breaker

Step 3: Switch on the battery or the breaker, button, DC switch of the battery (see documentation of the battery manufacturer).

Step 4: Check the LCD screen and perform **Forced Discharge** and **Forced Charge** through the setting path **Menu>Mode Select >Manual** to verify if the charging and discharging of battery is normal.

Step 5: Check whether the current **Safety Code** complies with the local grid-tied regulations. Normally, the factory setting is set with the local regulations.

Step 6: Check whether the meter/CT is correctly connected.

- » If CT is connected, please check the CT connection status through the path: **Menu>Setting>Advance Setting>Meter/CT Settings>Meter/CTCheck**. If CT is not well connected, the system will prompt **CTMeterConFault** alarm.



- » If meter is connected, please set the meter connection through the setting path: **Menu>Setting>Advance Setting>Meter/CT Settings** and check the meter connection status through the path: **Meter/CT Settings>Meter/CTCheck**. If meter is not well connected, the system will prompt **Meter Fault** alarm.



9.3 Checking after Power-on

- Step 1:** Check whether the inverter has any abnormal noise.
- Step 2:** Check whether the indicator lights report an error and whether the LCD screen displays the error message.
- Step 3:** Check whether the data of PV, grid and battery are normal through the LCD screen.
- Step 4:** Check whether the working mode is consistent with what had been set through LCD screen or the SolaX Cloud App.

9.4 Operation of Lockable DC Switch

This series of inverters are provided with two kinds of DC switches: general version (without lock; applied to most countries and regions) and lockable version (with lock; applied to Australia and New Zealand).

Three states of lockable DC switch

The lockable version includes 3 states: ON, OFF, and OFF+Lock. The DC switch is in the OFF state by default.

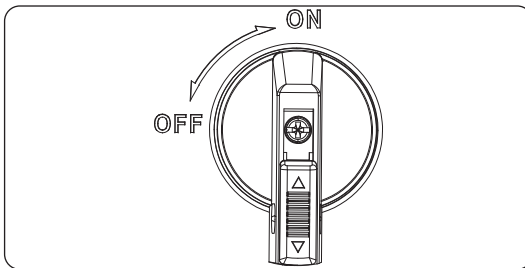

Figure 9-3 ON state

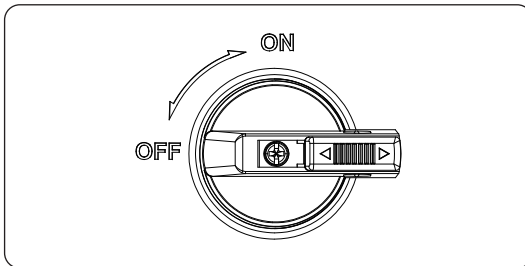

Figure 9-4 OFF state

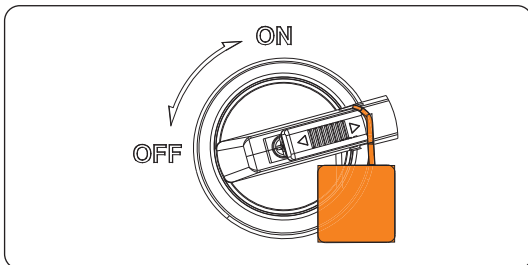

Figure 9-5 OFF+Lock state

Operation of lockable DC switch

- Turn on the DC switch: Rotate the DC switch from OFF state to ON state.

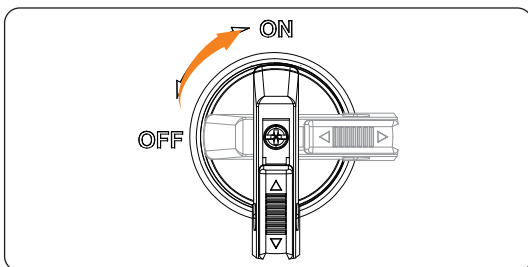

Figure 9-6 Turning on the DC switch

- Turn off the DC switch: Rotate the DC switch from ON state to OFF state.

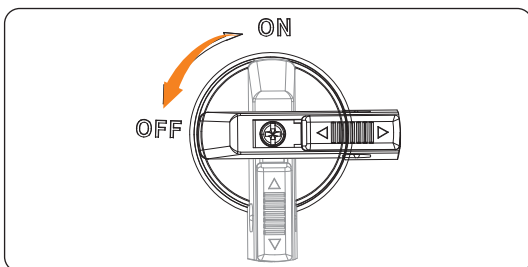

Figure 9-7 Turning off the DC switch

- Lock the DC switch:
 - a. Rotate the lock to the left side;
 - b. Push the lock upward (as shown in the diagram below).
 - c. Secure the DC switch with a lock (Please prepare a lock in advance).

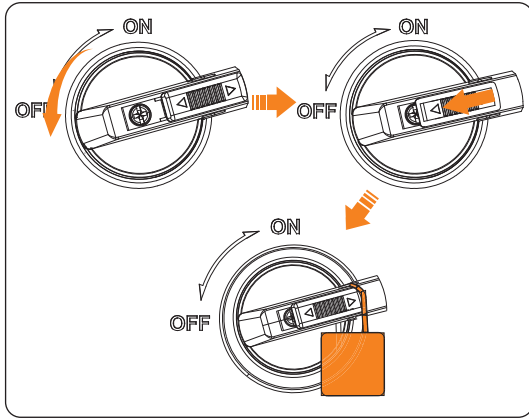

Figure 9-8 Locking the DC switch

- Unlock the DC switch:
 - a. Push the lock down (as shown in the diagram below);
 - b. Wait for it to return to OFF state.

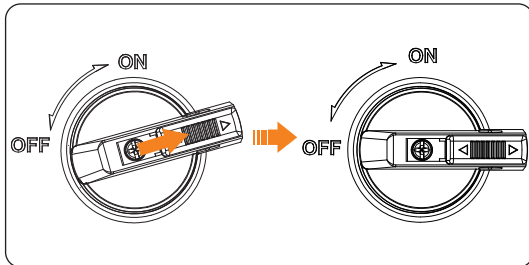

Figure 9-9 Unlocking the DC switch

10 Operation on LCD

10.1 Introduction of Control Panel

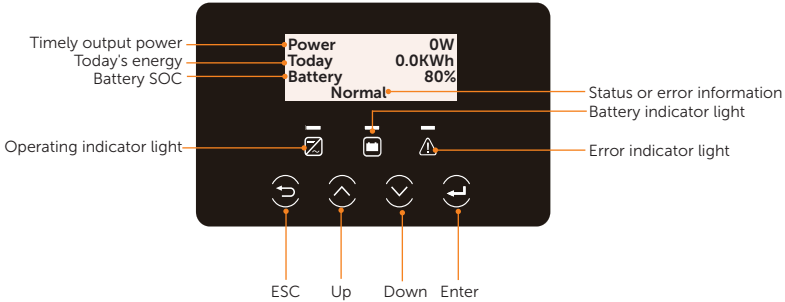

Figure 10-1 Control Panel

- In a normal state, the **Power**, **Today** and **Battery** information will be displayed. You can press the keys to switch information.
- In an error state, the fault message and error code will be displayed, please refer to "[12.2 Troubleshooting](#)" for corresponding solutions.

Table 10-1 Definition of indicators













LED indicator	Status	Definition
 Operating	 Light on	The inverter is in a normal state.
	 Blinking	The inverter is in a waiting or checking state.
 Error	 Light on	The inverter is in a fault state.
 Battery	 Light on	The battery communication is in a normal state.
	 Blinking	The battery is in an idle state.

Table 10-2 Definition of keys

Key	Definition
 ESC key	Exit from the current interface or function
 Up key	Move the cursor to the upper part or increase the value
 Down key	Move the cursor to the lower part or decrease the value
 Enter key	Confirm the selection

10.2 Introduction of Main Interface

The main interface is the default interface, the inverter will automatically jump to this interface when the system starts up successfully or is not operated for a period of time.

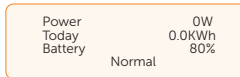

- **Power** means the timely output power.
- **Today** means the energy generated within the day.
- **Battery** means the battery SOC.
- **Normal** means the inverter is in normal status. When the inverter is in fault status, the error code and information will be displayed.

10.3 Introduction of Submenus Interface

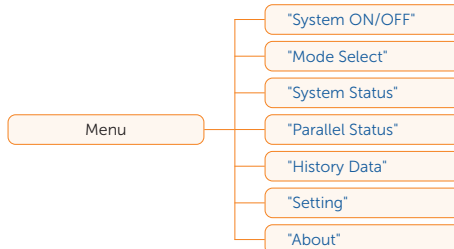

There are seven submenus in the menu that can be selected for relevant setting operations.

- **System ON/OFF:** Switch on and off the inverter.
- **Mode Select:** Select the working mode of the inverter, including **Self Use**, **Feed-in Priority**, **Backup Mode**, **Manual**, **Peaking Shaving** and **TOU**.

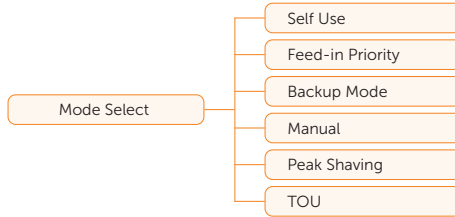

- **System Status:** Display the real-time value of PV, battery, etc. Including **PV1**, **PV2**, **Battery**, **On-grid**, **EPS** and **Meter/CT**.

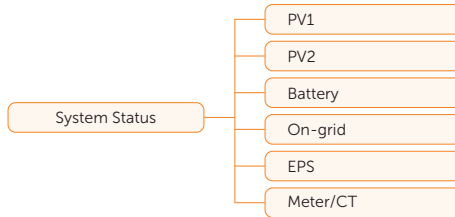

- **Parallel Status:** Display all the status data from master inverter when the inverters are parallel-connected.
- **History Data:** Display the history data of **On-grid**, **EPS**, **E_Feedin**, **E_USERDEF** and **Error Log**.

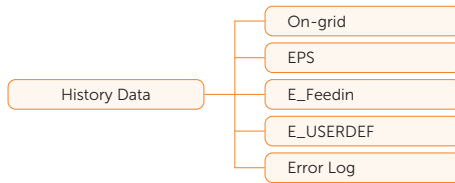

- **Setting:** Set the parameters of the inverter, including **User Setting** and **Advance Setting**.

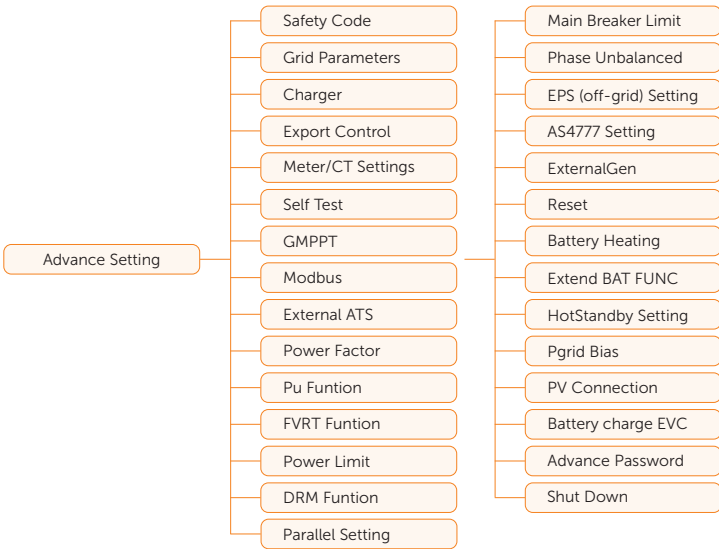
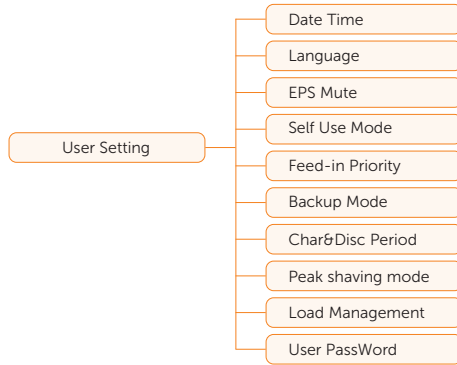

- **About:** Display the information about **Inverter**, **Battery 1**, **Battery 2**, and **Internal code**.

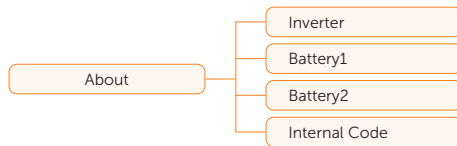

- » **Peak Shaving:** When the power consumption from the grid exceeds the set **PeakLimits** value, the battery is allowed to discharge power. The excess power beyond the limit is provided by the combination of photovoltaic and battery to ensure that the maximum power purchased from the grid does not exceed the set limit. When the current working mode is peak shaving, you can view the set **PeakLimits**.



- » **Charging:** The power of PV will charge the battery as much as possible to the set SOC of **Charge BAT to** (%). When the battery reaches the set SOC, the surplus power will perform **Self-use** mode or supply to the grid (based on the system setup), at this point, **Charge from grid** is not allowed. When the current working mode is **Charging**, you can view the target charging SOC.

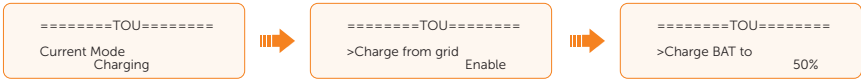

- » **Discharging:** If allowed by the battery, the system outputs a specified power from the grid based on the set output percentage, controlling the power at the AC terminal. You need to set the **RatePower** (%) through Web or App when choosing Discharging mode. When the battery **Discharge to** (%) reaches the set SOC, the inverter performs **Self-use** mode. You can view the **Rate of AC Power** and **Discharge to** (%) here.

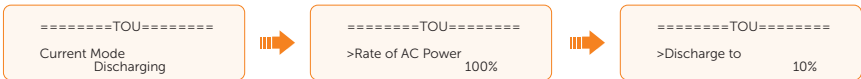

10.6 System Status

Displaying path: **Menu>System Status**

After entering into the **System Status** interface, the status of PV, Battery, On-grid, EPS, Meter/CT will be displayed on the LCD as follows:

- **PV:** Information of **PV1** and **PV2** contains input voltage, current and power of each PV.



- Battery:** Information of battery contains the voltage, current, power, SOC, cell temperature and BMS connection status. Positive value with power means charging; negative value means discharging.

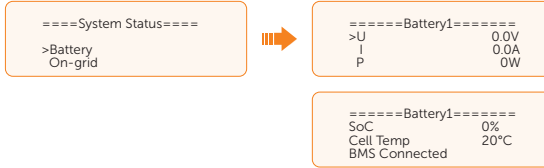

- On-grid:** Information contains the voltage, current, frequency, and output power of Grid connection terminal. The "A", "B" and "C" in **On-grid A**, **On-grid B** and **On-grid C** refers to L1, L2 and L3 respectively. The figure below will take **On-grid A** as an example. Positive value with power means power output; negative value means power input.

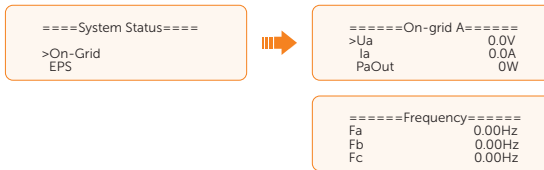

- EPS:** Information contains apparent power, voltage, current, active power and frequency of EPS (off-grid) connection terminal when it is disconnected from the grid. The "A", "B" and "C" in **EPS A**, **EPS B** and **EPS C** refers to L1, L2 and L3 respectively. The figure below will take **EPS A** as an example.

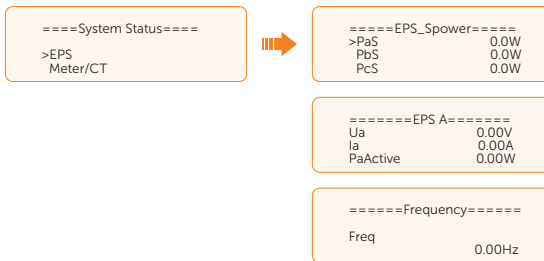

- Meter/CT:** Information contains feed-in power of L1, L2 and L3 detected by the connected meter or CT. Positive value with Pfeedin means power fed into grid; negative value means power taken from grid.



10.7 History Data

Displaying path: **Menu>History Data**

After entering the **History Data** interface, the status of **On-grid**, **EPS**, **E_Feedin**, **E_USERDEF**, **Error Log** will be displayed on the LCD as follows:

- **On-grid**: A record of the output and input electric energy of the inverter today and the total (through Grid connection terminal).
 - » **Output Today**: Output electric energy of the inverter today.
 - » **Output Total**: Total output electric energy since the inverter activated for the first time.
 - » **Input Today**: Input electric energy of the inverter today.
 - » **Input Total**: Total input electric energy since the inverter activated for the first time.

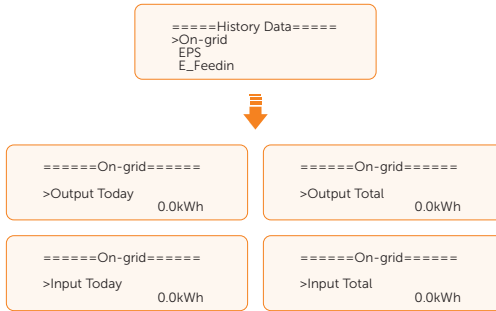

- **EPS**: A record of the output electric energy of the inverter today and the total, when it is disconnected from grid (through EPS (off-grid) connection terminal).

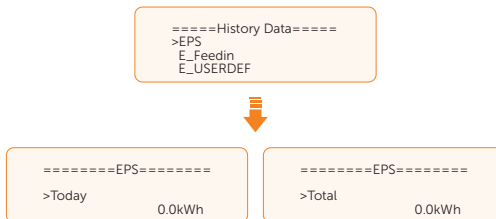

- **E_Feedin**: The total electricity fed into or taken from the grid since the inverter activated for the first time and on that day (detected by Meter/CT).
 - » **Feedin Today**: Electricity sold to grid today.
 - » **Feedin Total**: Total electricity sold to grid since the inverter activated for the first time.
 - » **Consume Today**: Electricity bought from grid today.

- » **Consume Total:** Total electricity bought from grid since the inverter activated for the first time.

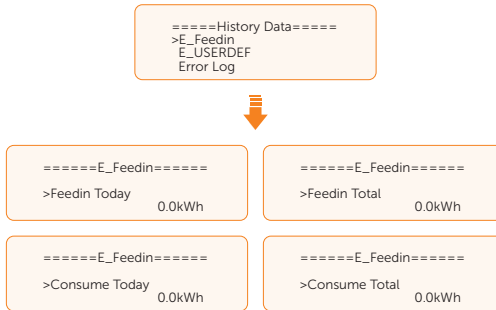

- **E_USERDEF:** The output electricity of the connected on-grid inverter totay and the total (detected by Meter 2). This function is only available when meter 2 is connected.

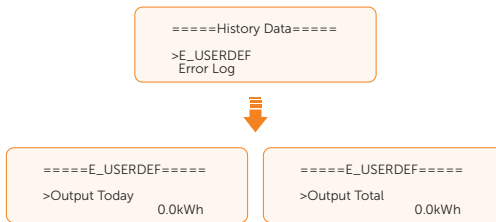

- **Error Log:** Display the recent six error messages. Information contains date and time error happened, error code and error description.



10.8 Setting

Settings includes User Settings and Advanced Settings.

10.8.1 User Setting

Setting path: **Menu>Setting ("0 0 0 0 ")>User Setting**

NOTICE!

The default password for **User Setting** is "0 0 0 0".

Setting Date & Time

You can set the current date and time of the installation site.

The display format is "2023-06-16 14:00", in which the first four numbers represent the year (e.g. 2000~2099); the fifth and sixth numbers represent the month (e.g. 01~12); the seventh and the eighth numbers represent the date (e.g. 01~31). The remaining numbers represent the time.



Setting Language

This inverter provides multiple languages for customers to choose, such as English, Deutsch, francais, Polskie, Espanol, Português. The default language is English.



Setting EPS Mute

When the inverter is running in EPS Mode, you can choose whether the buzzer is turned on or not.

- Select **Yes**, the buzzer mutes.
- Select **NO**, the buzzer will sound every 4 seconds when the battery SOC is > EPS min. SOC. When the battery SOC is equal to EPS min. SOC, the buzzer will sound with higher frequency at every 400 ms. This function is turned off by default.



Setting Self Use Mode

Please refer to "2.7.1 Self-use Mode" for working logic of this mode.

- **Min SOC:** Default: 10%; range: 10%~100%
 - » The minimum SOC of the battery. The battery will not discharge power when the SOC of the battery reaches this value.

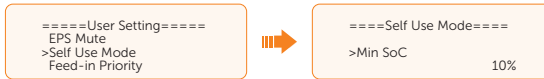

- **Charge from grid:**
 - » You can set whether the power can be taken from the grid to charge the battery in the forced charging period. When **Charge from grid** is set to **Enable**, the grid power is allowed to charge the battery; when it is set to **Disable**, the grid power is not allowed to charge the battery.



- **Charge battery to:** Default: 10%; range: 10%~100%
 - » Set the target SOC to charge the battery from grid in the forced charging period (applicable only when the **Charge from grid** is enabled).
 - » You can set your own target value, i.e. during the forced charging period, the inverter will use both PV & grid power to charge the battery to the target value. If the PV power is still sufficient (enough for load and there is excess power), the inverter will continue to charge the battery.

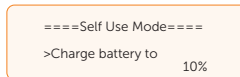

Setting Feed-in Priority

Please refer to "2.7.2 Feed-in Priority" for working logic of this mode.

- **Min SOC:** Default: 10%; range: 10%~100%
 - » The minimum SOC of the battery. The battery will not discharge power when the SOC of the battery reaches this value.



- **Charge battery to:** Default: 50%; range: 10%~100%
 - » Set the target SOC to charge the battery from grid in the forced charging period.

- » You can set your own target value, i.e. during the forced charging period, the inverter will use both PV & grid power to charge the battery SOC to the target SOC value, after the battery SOC meets the target value, if the PV power is still sufficient, the surplus power will be fed into the grid.

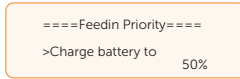

Setting Backup Mode

Please refer to "2.7.3 Backup Mode" for working logic of this mode.

- **Min SOC:** Default: 30%; range: 30%~100%
 - » The minimum SOC of the battery The battery will not discharge power when the SOC of the battery reaches this value.



- **Charge battery to:** Default: 50%; range: 30%~100%
 - » In this mode, the charge from grid function is turned on by default, and customers can set the target value by themselves, that is, during the forced charging period, the inverter will use both PV & grid power to charge the battery to the target value. If the PV power is still sufficient (enough for load and there is excess power), the inverter will continue to charge the battery.

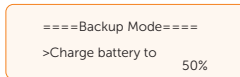

Setting Char&Disc Period

Here you can set the **Forced Charge Perid** and **Allowed Discharge Period**.

If two charging and discharging periods are needed, enable the **Function Control** to activate the **Char&Disc Period2**.

- **Char&Disc Period:** You can set the charge and discharge time according to your own needs. The default time axis of the system is 24h.
 - » **Forced Charge Period Start Time:** Time to start charging; default: 00:00; range: 00:00~23:59
 - » **Forced Charge Period End Time:** Time to stop charging; default: 00:00; range: 00:00~23:59
 - » **Allowed Disc Period Start Time:** Time allows to start discharging (The charging or discharging of the battery depends on the working mode.); default: 00:00; range: 00:00~23:59

- » **Allowed Disc Period End Time:** Time to stop discharging; default: 23:59; range: 00:00~23:59

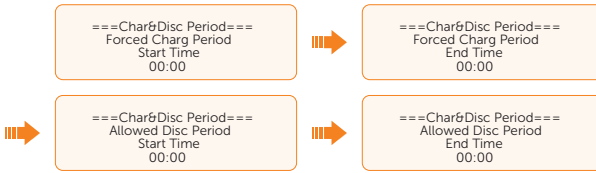

- **Char&Disc Period2:** The second time axis is closed by default. If two charging and discharging periods are needed, turn on the charging and discharging period 2. This period will hold the same setting logic as **Char&Disc Period**.

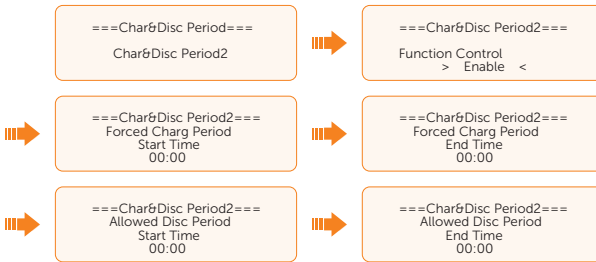

NOTICE!

- The charging and discharging period is only applicable for self-use mode, feed-in priority and backup mode.
- In the period not set as forced charging period and allowed discharging period, the battery can be charged but can not discharge power.
- In the period simultaneously set as forced charging period and allowed discharging period, the battery will be charged forcibly.

Setting Peak shaving mode

Please refer to "2.7.4 Peak Shaving Mode" for working logic of this mode.

NOTICE!

- To set the parameters for the peak shaving mode, please select **Peak Shaving** in **Menu > Mode Select** in advance. Otherwise, the mode will not be displayed under the **Menu > Setting > User Setting** path.
- **DisChgPeriod1:** To set **ShavingStartTime**, **ShavingEndTime** and **PeakLimits**. **DisChgPeriod1** can be regarded as Peak shaving period. This period should be set to cover load peaks. Battery will be discharged to shave load peak until battery SOC drops to Min SOC (10% by default).
 - » **PeakLimits1:** Default: 0 W, range: 0-60000 W

Once the consumption (from the grid) reaches this value, the inverter will start shaving to keep the consumption lower than this value.

- » **ShavingStartTime:** Default: 7:00

The battery starts discharging to shave consumption from the set time.

- » **ShavingEndTime:** Default: 15:00

The battery stops discharging at the set time.

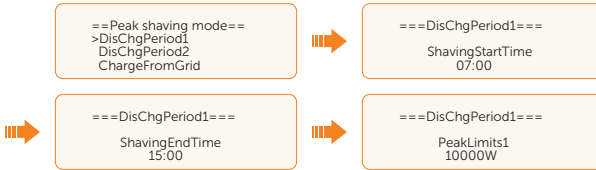

- **DisChgPeriod2:** Same working logic with DisChgPeriod1

- » **PeakLimits2:** Default: 0 W, range: 0-60000 W

- » **ShavingStartTime:** Default: 19:00

The battery starts discharging to shave consumption from the set time.

- » **ShavingEndTime:** Default: 23:00

The battery stops discharging at the set time.

- **ChargeFromGrid:** It can be used in specific time period. This period allows the inverter to take energy from grid to charge battery in order to have enough backup for peak shaving. Please note that this period starts from ShavingEndTime2, end until ShavingStartTime1.

- » **Enable:** Activate the function of **ChargeFromGrid** to allow the inverter taking grid energy to charge battery. The **ChargePowerLimits** and **MAX_SOC** will be displayed only when **ChargeFromGrid** is enabled.

- » **ChargePowerLimits:** Default: 1000 W; range: 0-60000 W

Settable target power taken from grid. Inverter will use this target power taken from grid to charge battery.

- » **MAX_SOC:** Default: 50%; range: 10%-100%

Inverter will take grid energy to charge battery until battery SOC reaches this value.

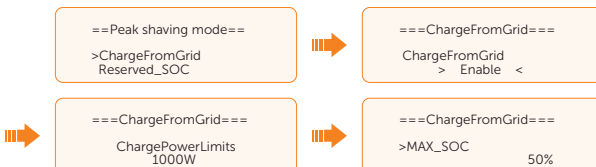

- **Reserved_SOC:** Default: 50%; range: 10%-100%

- » It can be used in specific time period. In this period, the inverter does not allow taking grid energy to charge the battery. PV is the only way to charge the battery and PV will charge the battery first. Inverter will not supply power to loads until battery SOC is higher than the **Reverved_SOC** in order to save enough energy for later shaving period.

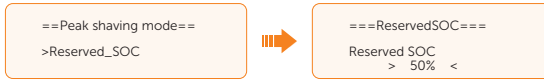

Dry contact

Load management

This function is applicable for the first generation of SolaX Adapter Box.

- Enter the **Load Management** interface through the path: **Menu>Setting>User Setting>Dry Contact>Load Management**.

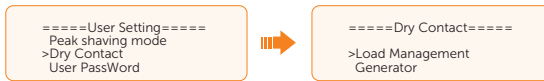

- Set the **Load Management** mode. Overall three heat pump operation modes are available for you to choose:

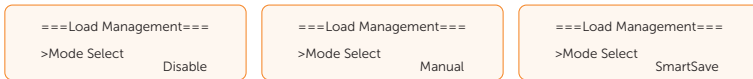

- » **Mode 1 Disable:** The Adapter Box function is disabled under this operation mode.
 - » **Mode 2 Manual:** In this operating mode, you can change the Adapter Box from on to off, or from off to on through settings on the inverter or through SolaX App.
 - » **Mode 3 SmartSave:** In this operating mode, users can set a series of parameters on the SolaX inverter to intelligently control how and when the heat pump works for them (see Step C).
- Set the parameters for mode **SmartSave**. In this mode, you can set **Thresholds on Feedin power**, **Thresholds off Consumption**, **Thresholds off Battery SOC**, **Mnimum duration per on-signal**, **Minimum duration per day** and **Schedule** in accordance with your actual needs.

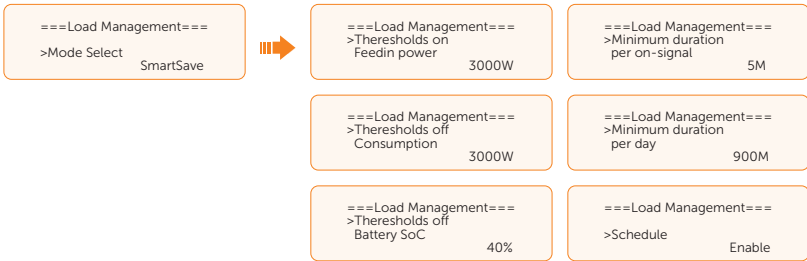

- Setting thresholds on/off
 - » **Thresholds on Feedin power:** Once the feed-in power is greater than or equal to the set value, the Adapter Box will turn on and the heat pump will heat the water up to a higher temperature.
 - » **Thresholds off Consumption:** Once the power consumption (from the grid) is greater than or equal to the set value, the Adapter Box will be turned off, SolaX system stops providing electricity to heat pump.
 - » **Thresholds off Battery SOC:** Once the battery SOC drops to the set value, the Adapter Box will turn off, SolaX system stops providing electricity to heat pump.
- Setting minimum / maximum duration
 - » **Minimum duration per on-signal:** Minimum working hours, heat pump will work at least the time set here every time been activated. High priority than other power threshold settings.
 - » **Maximum duration per day:** Maximum working hour limitation per day. High priority than other power threshold settings.
- Setting schedule
 - » **Schedule:** Set the heat pump working periods flexibly (heat pump on and off periods). High priority than other power threshold settings. Two work periods can be set.

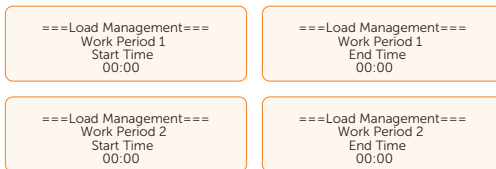

- Mode Priority: **Minimum/Maximum duration > Schedule >Thresholds on/off**

Generator

When the generator is controlled by dry contact instead of ATS, select **Generator**.

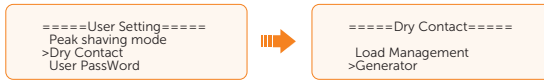

Setting User Password

The default password is "0 0 0". You can reset the password here.

10.8.2 Advanced Setting

Setting path: **Menu>Setting>Advance Setting**

NOTICE!

- All the adjustable parameters including safety code, grid parameter, export control, etc. can be modified under the permissions of installer password. Unauthorized use of the installer password by unauthorized persons can lead to incorrect parameters being inputted, resulting in power generation loss or violation of local regulation. Get the installer password from the dealer and never open the password to unauthorized person.

Setting Safety Code

NOTICE!

- The inverter cannot be connected to the grid before the safety code is correctly set. If there is any doubt about your safety code where the inverter installed, please consult your dealer or SolaX service for details.
- The setup will vary from different safety codes.

Here you can set safety code according to different countries and grid-tied standards. In addition, the inverter has an **User Defined** option which allows you to customize relevant parameters with a wider range.

There are several standards to choose from, please refer to the LCD screen on the inverter.

For Australia, select Australia Region A / B / C in compliance with AS/NZS 4777.2. Only after the safety code setting is completed, some designated parameters in the inverter system will take effect according to the corresponding safety regulations.

Table 10-3 Region settings

Region	Australia A	Australia B	Australia C	New Zealand	
Standard Code Name	AS4777_2020_A	AS4777_2020_B	AS4777_2020_C	New Zealand	Setting Range
OV-G-V	265 V	265 V	265 V	265 V	230-300 V

Operation on LCD

Region	Australia A	Australia B	Australia C	New Zealand	
Standard Code Name	AS4777_2020_A	AS4777_2020_B	AS4777_2020_C	New Zealand	Setting Range
OV-GV1-T	1.5 s	1.5 s	1.5 s	1.5 s	
OV-G-V2	275 V	275 V	275 V	275 V	230-300 V
OV-GV2-T	0.1 s	0.1 s	0.1 s	0.1 s	
UN-G-V1	180 V	180 V	180 V	180 V	40-230 V
UNGV1-T	10 s	10 s	10 s	10 s	
UN-G-V2	70 V	70 V	70 V	70 V	40-230 V
UNGV2-T	1.5 s	1.5 s	1.5 s	1.5 s	
OV-G-F1	52 Hz	52 Hz	55 Hz	55 Hz	50-55 Hz
OVGF1-T	0.1 s	0.1 s	0.1 s	0.1 s	
OV-G-F2	52 Hz	52 Hz	55 Hz	55 Hz	50-55 Hz
OVGF2-T	0.1 s	0.1 s	0.1 s	0.1 s	
UN-G-F1	47 Hz	47 Hz	45 Hz	45 Hz	40-50 Hz
UNGF1-T	1.5 s	1.5 s	5 s	1.5 s	
UN-G-F2	47 Hz	47 Hz	45 Hz	45 Hz	45-50 Hz
UNGF2-T	1.5 s	1.5 s	5 s	1.5 s	
Startup-T	60 s	60 s	60 s	60 s	15-1000 s
Restore-T	60 s	60 s	60 s	60 s	15-600 s
Recover-VH	253 V	253 V	253 V	253 V	
Recover-VL	205 V	205 V	205 V	198 V	
Recover-FH	50.15 Hz	50.15 Hz	50.15 Hz	50.15 Hz	
Recover-FL	47.5 Hz	47.5 Hz	47.5 Hz	47.5 Hz	
Start-VH	253 V	253 V	253 V	253 V	
Start-VL	205 V	205 V	205 V	198 V	
Start-FH	50.15 Hz	50.15 Hz	50.15 Hz	50.15 Hz	
Start-FL	47.5 Hz	47.5 Hz	47.5 Hz	47.5 Hz	

Setting Grid parameters

The default value is the specified value under the current safety regulations. The contents will be displayed according to the requirements of local laws and regulations. Please refer to the actual contents displayed on the LCD screen on the inverter.

```
====Grid Parameters====
>Overvoltage_L1
Undervoltage_L1
OverFreq_L1
```

Setting Charger

The inverter is compatible with lithium-ion battery and lead-acid battery. You can set the charge & discharge parameters of battery.

Setting lead-acid battery: Select the battery type of **Lead Acid** and set the corresponding parameters.



- **Charge Equalization:** Default: 260 V; range: 160-800 V

Charge the battery with the maximum charging current until the battery voltage reaches the set **Charge Equalization** and then the current will be gradually reduced.

```
====Charger====
>Charge Equalization
00.0V
```

- **Charge float:** Default: 270 V; range: 160-800 V

Charging the battery with the set **Charge float** and the battery SOC will be replenished with a small current.

```
====Charger====
>Charge float
00.0V
```

- **Discharge Cut:** Default: 240 V; range: 160-800 V

In modes other than the Backup mode, the battery does not continue to discharge when the voltage drops to the set **Discharge Cut**.

```
====Charger====
>Discharge Cut
00.0V
```

- **Discharge BackUp:** Default: 245 V; range: 160-800 V

In the Backup mode, the battery does not continue to discharge when the voltage drops to the set **Discharge BackUp**.

```
====Charger====  
>Discharge BackUp 00.0V
```

- **Max Charge:** Default: 30 A
 - » Maximum charging current of battery.
- **Max Discharge:** Default: 30 A
 - » Maximum discharging current of battery.
- **Charger upper limit:** Default: 60%, range: 10%-100%
 - » The maximum battery SOC when charging.

```
====Charger====  
>Max Charge  
Current 30A
```

```
====Charger====  
>Max DisCharge  
Current 30A
```

```
====Charger====  
>Charger upper limit 60%
```

Setting lithium-ion battery: Select the battery type of **Lithium** and set the corresponding parametes.

- **Max Charge:** Default: 30 A
 - » Maximum charging current of battery.
- **Max Discharge:** Default: 30 A
 - » Maximum discharging current of battery.
- **Charger upper limit:** Default: 60%, range: 10%-100%
 - » The maximum battery SOC when charging.

```
====Charger====  
>Max Charge  
Current 30A
```

```
====Charger====  
>Max DisCharge  
Current 30A
```

```
====Charger====  
>Charger upper limit 60%
```

Setting Export Control

This function allows the inverter to control the output power to the grid. If the user does not want to feed power to the grid, set **User Value** to "0".

```
====Export Control====  
User Value 300000W
```

NOTICE!

- Under Safety Code AS4777.2, **Export Control** is in the path of **Advance Setting>AS4777 Setting**. You can set the **Soft Limit** and **Hard Limit** of **Export Control** to control the power output to grid. Please refer to section "**AS4777 Setting**" for details.

Meter/CT Setting

CT or electricity meter is needed to connect with the inverter. CT is set by default.

NOTICE!

- If the user has other power generation equipment (such as inverter) at home and wants to monitor both, the inverter provides Meter2 communication function to monitor the power generation equipment.

- Select and enter the **Meter/CT Setting** according to the setting path.
- Set the the parameters of Meter/CT:
 - » Case 1: Only CT for SolaX inverter

CT is set by default. Choose the supported CT type. You can check the connection status in **Meter/CT Check**.



- » Case 2: Only Meter 1 for SolaX inverter

Enable the Meter 1 selection and set the meter address and direction. You can check the connection status in **Meter/CT Check**.

NOTICE!

- CT and Meter 1 can not be used simultaneously.
- **Installation Check** in **Meter/CT Check** is for checking whether the meter/CT is properly connected when the inverter is well installed. **Cyclic Check** in **Meter/CT Check** is for periodically checking whether the meter/CT is in good condition when the inverter is running.



- » Case 3: CT for SolaX inverter; Meter 2 for another power generation equipment

For CT setting, please refer to Case 1. For Meter 2 setting, please set the address and direction of Meter2 based on actual connection. You can check the connection status in **Meter/CT Check**.



- » Case 4: Meter 1 for SolaX inverter; Meter 2 for another power generation equipment

Refer to Case 2 for Meter 1 setting and Case 3 for Meter 2 setting. You can check the connection status in **Meter/CT Check**.

Setting Self Test (only for CEI 0-21)

The self test function allows users to test the following items: **Full Test**, **Ovp (59.S2) test**, **Uvp (s1) test**, **Uvp (27. s2) test**, **Ofp (81> .S1) test**, **Ufp (81 <.S1) test**, **Ufp (81> .S2) test**, **Ufp (81 <.S2) test**, **Ovp10 (59. s1) test**.

In the **Self Test** interface, the user can select **All Test** or a single test item for testing. All tests take about 6 minutes. And it will display **Success**. For a single test item, it takes about a few seconds or minutes.

Before testing, make sure that the inverter is connected to the grid. Click **Test Report** to view the test results of all items.

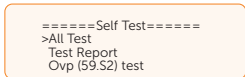

Setting GMPPT

You can set the shadow tracking speed with four options, which are **Off**, **Low**, **Middle**, and **High**. This function is off by default.

- **Off**: Switch off the shadow tracking function.
- **Low**: Scan the shadow every four hours.
- **Middle**: Scan the shadow every three hours.
- **High**: Scan the shadow per hour.

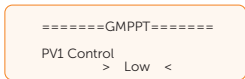

Setting Modbus

You can communicate with other SolaX equipments, such as EV-Charger, DataHub and Adapter Box G2.

- Select and enter **Modbus** interface;
- Select the equipment which needs to be connected and set the corresponding Baud Rate and Address. Take EV-Charger as an example. The default Baud Rate is 9600.

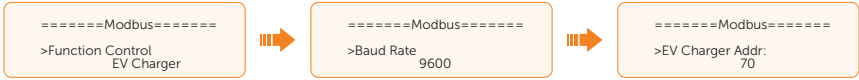

NOTICE!

- When two equipments need to be connected at the same time, the Baud rate of the two equipments shall be set to the same.

c. Check the connection status.

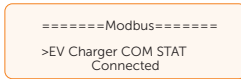

Setting External ATS

When X3-Matebox Advanced / X3-PBOX-150K G2 / X3-PBOX-60K G2 / Generator is connected in the system, please enable the **External ATS**.

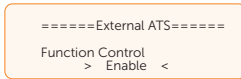

Setting Power Factor

The default value is the specified value under the current safety regulations. The contents will be displayed according to the requirements of local laws and regulations. Please refer to local grid requirements.

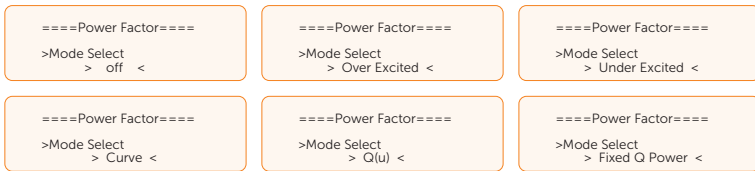

Table 10-4 Items under Power Factor

Off		
Over Excited	PF Value	
Under Excited	PF Value	
Curve	P1 PF	
	P2 PF	
	P3 PF	
	P4 PF	
	Power 1	
	Power 2	
	Power 3	
	Power 4	
	PflockInPoint	
	PflockOutPoint	
	3Tua	
	SetQuPower1	
	SetQuPower2	
	SetQuPower3	
SetQuPower4		
Q(u)	QuRespondV1	
	QuRespondV2	
	QuRespondV3	
	QuRespondV4	
	K	
	3Tua	
	QuDelayTimer	
	QuLockEn	
	Fixed Q Power	Q Power

For $Q(u)$, the curve required for the volt-var control mode can be referred to the below.

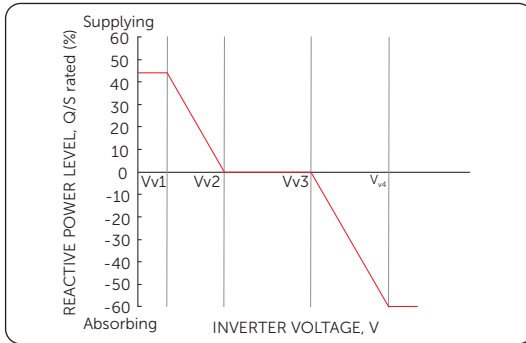

Figure 10-2 Curve for $Q(u)$

- Reactive power control, reactive power standard curve $\cos \varphi = f(P)$
 - » For VDE ARN 4105, the curve $\cos \varphi = f(P)$ should refer to curve A. The set default value is shown in curve A.

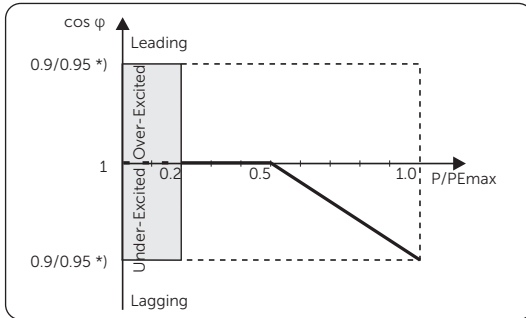

Figure 10-3 Curve A

*) If the P_{max} of the inverter ≤ 4.6 kW, the Power Factor is 0.95 at 1.0 power; if the P_{max} of the inverter > 4.6 kW, the Power Factor is 0.90 at 1.0 power.

- » For TOR, the curve $\cos \varphi = f(P)$ should be curve B. The set default value is shown in curve B.

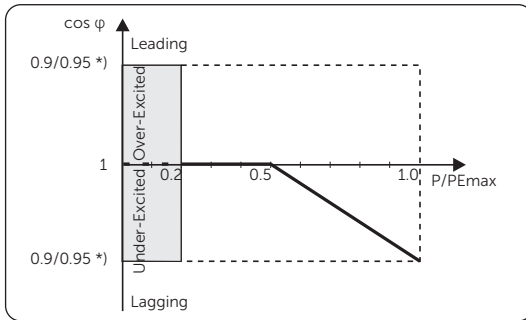

Figure 10-4 Curve B

*) Depend on the required Q capacity

- » For CEI 0-21, the default value of PFLockInPoint is 1.05. When $V_{ac} > 1.05V_n$, $P_{ac} > 0.2 P_n$, curve $\cos \varphi = f(P)$ corresponds to curve C.

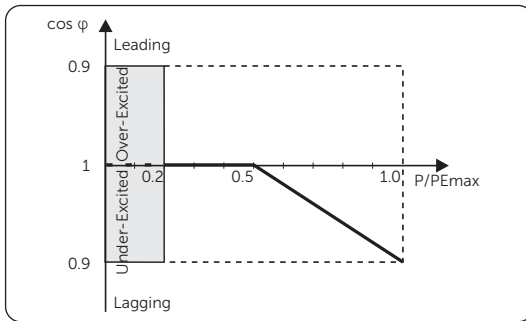

Figure 10-5 Curve C

- Reactive power control, reactive power standard curve $Q = f(V)$

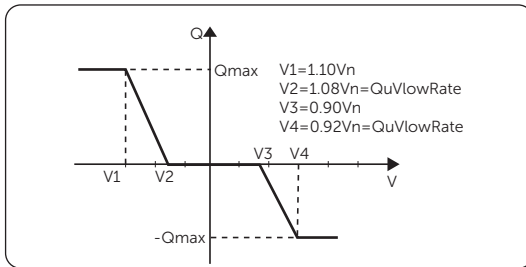

Figure 10-6 Curve $Q = f(V)$

Setting Pu Function

(Applicable to specific countries, please refer to local grid requirements.)

The Pu function is a volt-watt response mode required by certain national standards such as AS/NZS 4777.2. This function can control the active power of the inverter according to the grid voltage. You can set **Response Voltage**, **3Tau**, **PuPower**, **3Tau_Charge** and **Pu Type**.

The items in the **P(u) Function** interface will be adjusted in accordance with the local safety requirements and law regulations, casual modification is prohibited.



For P(u), the curve required for the volt-watt mode can be referred to the below.

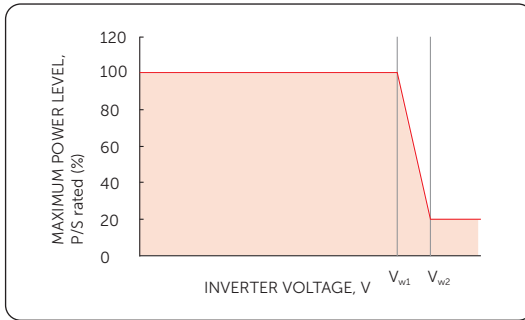
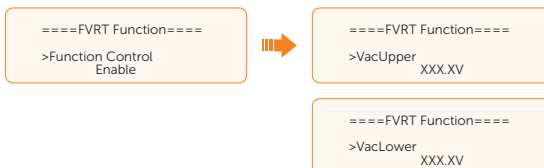

Figure 10-7 Curve for P(u)

Setting PVRT function

PVRT consists of HVRT (High Voltage Ride Through) and LVRT (Low Voltage Ride Through). With PVRT function, the series inverter can ensure continuous operation without disconnecting from the grid within a certain range of voltage sudden rise and drop in a certain time interval.

- **Enable:** Enable the PVRT function
- **VacUpper:** The voltage for high voltage ride through
- **VacLower:** The voltage for low voltage ride through



Setting Power Limit

Here you can set the rated output power by percentage.

The percentage of rated output power is used as the actual output power.

Proportion: Default: 1.00; range: 0.00-1.10

(For 8.3 kW and 15 kW inverter, the proportion can only be set to 0.00-1.00 and for other models of this series inverter, the proportion can be set to 0.00-1.10.)

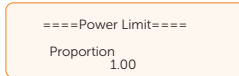

Setting DRM function (Applicable to AS/NZS 4777.2)

The DRM Function is a demand response method required by the AS/NZS 4777.2 standard and is only applicable to Australia and New Zealand.

The function is enabled by default.

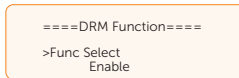

Setting Main Breaker Limit

Due to power limit, the current of Meter or CT must be abide by the utility's requirements. You can set the corresponding amperage according to the utility's requirements. Failure to set the current may cause a circuit breaker fault of main switchboard, thus affecting the charging and discharging of battery.

The default value is 100 A, range: 10-250 A

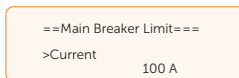

Setting Phase Unbalanced

This function controls the distribution of AC output power. **Disable** is the default setting.

- **Enable** mode: Each phase of power will be independently output according to the corresponding loads connected with each phase.

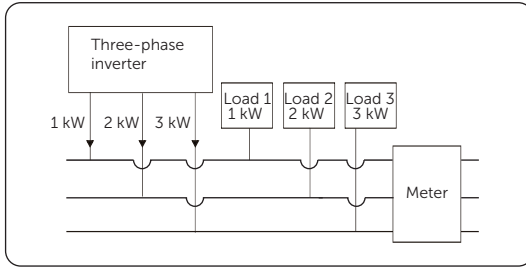

Figure 10-8 Phase Unbalanced enabled

- **Disable mode:** Three-phase power balanced output, with equal power in each phase. The total power output is determined by the total load power of the three phases.

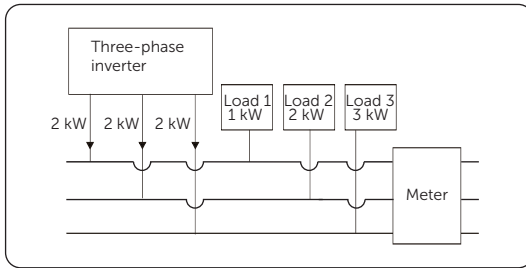
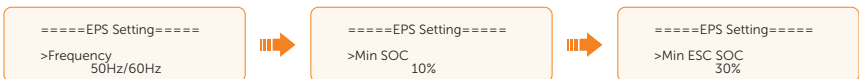

Figure 10-9 Phase Unbalanced disabled

EPS Setting

Select and enter **EPS Setting** interface and set **Frequency**, **Min SOC** and **Min ESC SOC**.

- **Frequency:** Default: 50 Hz.
 - » Output frequency of EPS (off-grid)
- **Min SOC:** Default: 10%, range: 10%-25%
 - » If the battery SOC is lower than the **Min SOC**, the inverter will prompt **BatPowerLow** and turn off if there is no PV input.
- **Min ESC SOC:** Default: 30%, range: 15%-100%
 - » In EPS (off-grid) mode, the minimum SOC required for re-entry EPS (off-grid) mode after **BatPowerLow** prompted. When the battery SOC reaches the **Min ESC SOC** through charging from PV, the inverter will automatically enter EPS (off-grid) mode from EPS Waiting mode.



- **Super-Backup:** Disabled by default. **Super-Backup** function enables the inverter to enter EPS (off-grid) mode when there is only PV input (no battery input).

```
====EPS Setting====  
>Super-Backup  
  Disable
```

- **UPS Switch:** Disabled by default. **UPS Switch** function enables the inverter to achieve fast on/off-grid switching.

```
====EPS Setting====  
>UPS Switch  
  Disable
```

AS4777 Setting

The function of **AS4777 Setting** is only activated when the **Safety Code** is set to AS4777, which is only applicable to Australia and New Zealand.

- a. Select and enter **AS4777 Setting** in **Advance Settings** interface. You will see **Exprot Control** (for active power output control) and **General Control** (for apparent power output control).

```
====AS4777 Setting====  
>Export Control  
  General Control
```

- b. Set the **Soft Limit** value and **Hard Limit** value for Export Control and General Control. The figure below will take the setup of Export Control as an example.

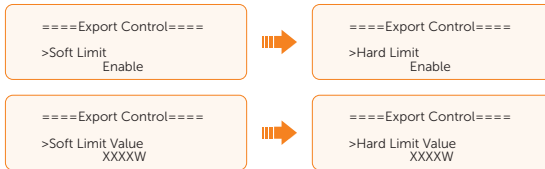

NOTICE!

- **Soft Limit:** Control the output value to grid within the set **Soft Limit Value**.
- **Hard Limit:** If the actual output value reaches the set **Hard Limit Value**, the system will automatically disconnect from grid and prompt error message on the LCD.

Reset

Here you can reset value of Error Log, Meter/CT, INV Energy and Wifi; and restore to the factory set.

- **Reset Error Log**

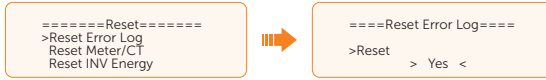

- **Reset Meter/CT**



- **Reset INV Energy**

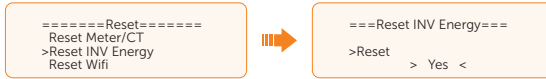

- **Reset Wifi**



- **Factory Reset**



Setting Battery Heating

This function is disabled by default and is only valid when the battery has the heating function. You can enable **Battery Heating** function to make the battery heated. And set the heating period.

- Enable the **Battery Heating** function.

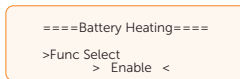

- Set the heating start time and end time for the battery. Two heating periods can be set.

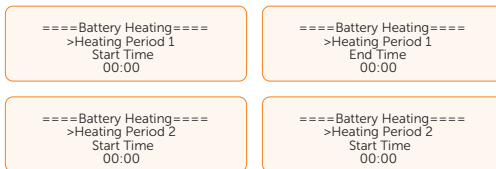

NOTICE!

- If the ambient temperature is extremely low, turning on battery heating will consume a significant amount of electrical energy.

Setting Extend BAT FUNC

This function allows for adding a new battery module to an existing system. It is only applicable and functional in on-grid mode and cannot be used in EPS (off-grid) mode. In on-grid mode, enabling this function will make the inverter to charge or discharge the battery SOC to approximately 40%. This function will turn to **Disable** automatically after 48 hours this function enabled.

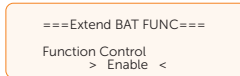

Setting HotStandby Setting

This function is mainly to reduce the energy losses of the system when the power of load is very low.

- **Enable:** When the power of load is very low and other conditions for entering hot standby are met, the inverter will enter **HotStandby** status to reduce system losses.
- **Disabled:** Even when the power of load is very low and other conditions for entering hot standby are met, the inverter will not enter **HotStandby** status and continue to output power to the load. It is disabled by default.

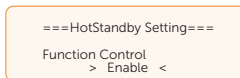

Setting Pgrid Bias

This function is disabled by default.

When the inverter has no power output:

- a. Check the **Meter/CT** value in **Menu>System Status>Meter/CT** when the function is disabled.

Disable: disabling this function

Grid: The inverter will discharge more energy to the grid.

INV: The inveter will be biased to charge power from the grid.

```

=====Pgrid Bias=====
Pgrid Bias
> Grid <

```

- b. **BlasPower**: Default: 40 W, settable range: 1 ~ 300 W (1 ~ 2%*Pn.max)
When you select **Grid** or **INV**, the inverter still discharges or charges much power to or from the grid. Please set **Bias Power** to limit the charging and discharging power.

```

=====Pgrid Bias=====
Bias Power
> 40 W <

```

Setting PV connection

This setting depends on the actual connection ways of PV panels.

```

====PV Connecrion=====
PV Mode
> MULTI <

```

Advanced Password

You can reset the advanced password here.

Shut Down

Shut Down is a function that allows remote control of the inverter to turn on or off with the local grid instructions, in order to restrict the amount of electricity fed to the grid. This instruction is implemented by disconnecting or connecting the external switch that is linked to the inverter.

- **Function Control**: **Use COM** and **Use OFF** are available for you to choose.
 - » **Use COM**: Switch on and off the inverter by means of an external switch connected to the **COM** communication terminal of the inverter.
 - » **Use OFF**: Switch on and off the inverter by means of an external switch connected to the **OFF** communication terminal of the inverter.

```

=====Shut Down=====
Function Control
> Use COM <

```

- **WaitChargeMode**: When **Use OFF** is selected, the **WaitChargeMode** interface will be displayed. This function enables the battery to be charged with photovoltaic power even when the inverter is in Wait mode.

```

=====Shut Down=====
WaitChargeMode
> Enable <

```

- **NO/NC: NO (Always on)** by default.
 - » **NO (Always on):** When the switch is disconnected, the inverter works normally, and when the switch is connected, the inverter shuts down.
 - » **NC (Always closed):** When the switch is connected, the inverter works normally, and when the switch is disconnected, the inverter shuts down.

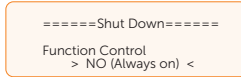

10.9 About

Displaying path: **Menu > About**

Here shows the basic information of the inverter, battery and internal code. After entering the **About** interface, you can check those information.

- Inverter
 - » Inverter SN, Register SN, ARM Verion, DSP version, On-grid Runtime, EPS Runtime
- Battery
 - » BatBrand, Bat_M SN (SN of BMS), Bat_PS1 SN (SN of battery module 1), Bat_PS2 SN (SN of battery module 2), Bat_PS3 SN (SN of battery module 3), Bat_PS4 SN (SN of battery module 4), Battery M Version (software version of BMS) and Battery S version (software version of battery module).
- Internal Code
 - » Internal code of inverter and battery.

11 Operation on SolaX App and Web

11.1 Introduction of SolaXCloud

SolaxCloud is an intelligent management platform for home energy, which integrates energy efficiency monitoring, device management, data security communication and other integrated capabilities. While managing your home energy device, it helps you optimize the efficiency of electricity consumption and improve the revenue of power generation.

11.2 Operation Guide on SolaXCloud App

11.2.1 Downloading and Installing App

Method 1: Select and scan the QR code below to download the app.

The QR codes are also available on the lower-right corner of the login page of our official website (www.solaxcloud.com), and the manual of the dongle.

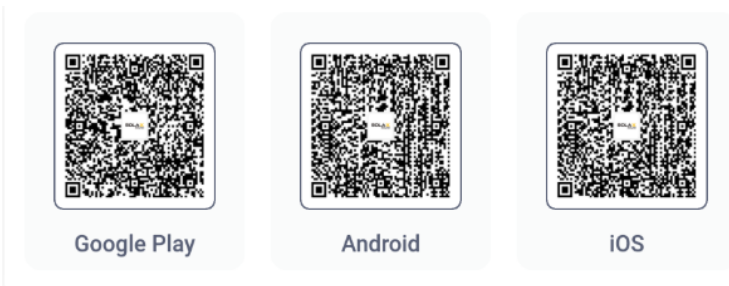

Figure 11-1 QR code

Method 2: Search for **SolaXCloud** in Apple Store APP or Google Play Store, and then download the app.

11.2.2 Operation on the App

For instructions on related operations, see the online help on the SolaXCloud App.

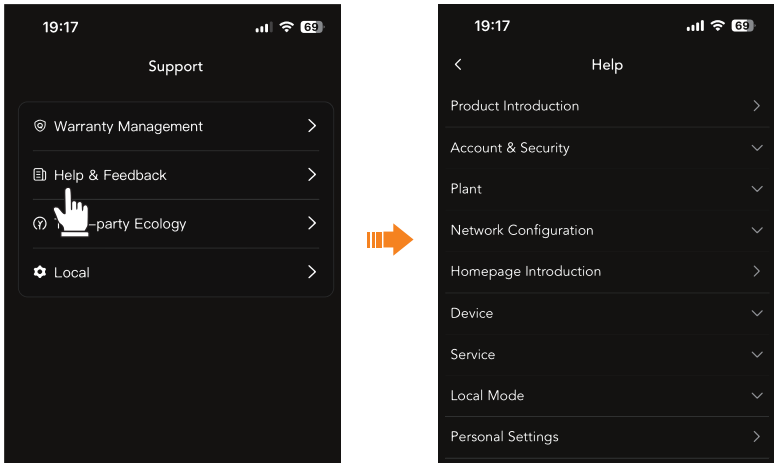

Figure 11-2 Online help on SolaXCloud

NOTICE!

- The screenshots in this chapter correspond to the SolaX Cloud App V5.5.0.

11.3 Operations on SolaXCloud Webpage

Open a browser and enter www.solaxcloud.com to complete registration, login, add site and other related operations according to the guidelines of guide.

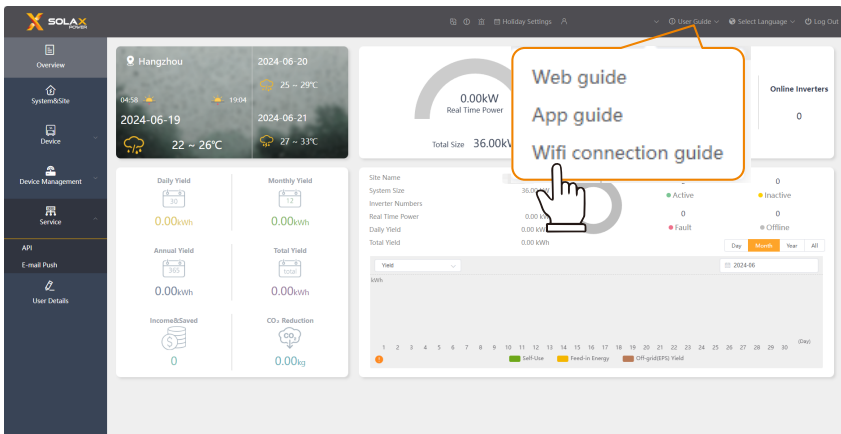

Figure 11-3 Guide on Web

12 Troubleshooting and Maintenance

12.1 Power Off

- Turn off the system by **System ON/OFF** on LCD screen.
- Turn off the AC switch between the inverter and the power grid.
- Set the DC switch to **OFF**.
- Switch off the battery or the breaker, button, DC switch of the battery (see documentation of the battery manufacturer).



- After the inverter is powered off, there may still be residual electricity and heat which may cause electric shocks and body burns. Please wear personal protective equipment (PPE) and start maintaining the inverter at least five minutes after power off.

12.2 Troubleshooting

This section lists the possible problems with the inverter, and provides information and procedures for identifying and resolving them. In case of any errors, check for the warnings or error messages on the system control panel or App, and then refer to the suggestions below. For further assistance, contact SolaX Customer Service. Please provide the model and SN of the inverter, and be prepared to describe the system installation details.

Table 12-1 Troubleshooting list

Error Code	Fault	Diagnosis and Solutions
IE 01	TZ Protect Fault	Overcurrent fault <ul style="list-style-type: none">Wait for a while to check if you're back to normal.Disconnect PV+ PV- and batteries, reconnect.Contact SolaX for help.
IE 02	Grid Lost Fault	Grid lost fault <ul style="list-style-type: none">Check the grid connection status.Contact SolaX for help.
IE 03	Grid Volt Fault	Power grid voltage overrun <ul style="list-style-type: none">Wait a moment, if the utility returns to normal, the system will reconnect.Please check if the grid voltage is within normal range.Contact SolaX for help.

Error Code	Fault	Diagnosis and Solutions
IE 04	Grid Freq Fault	Grid overfrequency <ul style="list-style-type: none">• Wait a moment, if the utility returns to normal, the system reconnects.• Contact SolaX for help.
IE 05	PV Volt Fault	PV overvoltage <ul style="list-style-type: none">• Check the output voltage of the PV panel.• Contact SolaX for help.
IE 06	Bus Volt Fault	<ul style="list-style-type: none">• Press the ESC key to restart the inverter.• Check if the PV input open circuit voltage is in the normal range.• Contact SolaX for help.
IE 07	Bat Volt Fault	Battery voltage fault <ul style="list-style-type: none">• Check if the battery input voltage is within normal range.• Contact SolaX for help.
IE 08	AC10mins Volt	Grid voltage out of range in the last 10 minutes <ul style="list-style-type: none">• The system will return to normal if the grid returns to normal.• Contact SolaX for help.
IE 09	DCI OCP Fault	DCI overcurrent protection fault <ul style="list-style-type: none">• Wait for a while to check if it's back to normal.• Contact SolaX for help.
IE 10	DCV OVP Fault	DCV EPS (Off-grid) overvoltage protection fault <ul style="list-style-type: none">• Wait for a while to check if it's back to normal.• Contact SolaX for help.
IE 11	SW OCP Fault	Software detection of overcurrent fault <ul style="list-style-type: none">• Wait for a while to check if it's back to normal.• Shut down photovoltaic, battery and grid connections.• Contact SolaX for help.
IE 12	RC OCP Fault	Overcurrent protection fault <ul style="list-style-type: none">• Check the impedance of DC input and AC output.• Wait for a while to check if it's back to normal.• Contact SolaX for help.
IE 13	Isolation Fault	Insulation fault <ul style="list-style-type: none">• Please check the wire insulation for damage.• Wait for a while to check if it's back to normal.• Contact SolaX for help.

Error Code	Fault	Diagnosis and Solutions
IE 14	Temp Over Fault	<p>Temperature out of range</p> <ul style="list-style-type: none"> • Check if the ambient temperature exceeds the limit. • Contact SolaX for help.
IE 15	Bat Con Dir Fault	<p>Battery direction fault</p> <ul style="list-style-type: none"> • Check if the battery cables are connected in the opposite direction. • Contact SolaX for help if it can not return to normal.
IE 16	EPS Overload Fault	<p>EPS (Off-grid) overload fault</p> <ul style="list-style-type: none"> • Shutdown the high-power device and press the ESC key to restart the inverter. • Contact SolaX for help if it can not return to normal.
IE 17	Overload Fault	<p>On-grid mode overload fault</p> <ul style="list-style-type: none"> • Shutdown the high-power device and press the ESC key to restart the inverter. • Contact SolaX for help if it can not return to normal.
IE 18	BatPowerLow	<p>Bat power low</p> <ul style="list-style-type: none"> • Shutdown the high-power device and press the ESC key to restart the inverter. • Charge the battery to a level higher than the protection capacity or protection voltage.
IE 19	BMS Lost	<p>Battery communication lost</p> <ul style="list-style-type: none"> • Check that the communication cable between the battery and the inverter are properly connected. • Contact SolaX for help if it can not return to normal.
IE 20	Fan Fault	<p>Fan fault</p> <ul style="list-style-type: none"> • Check for any foreign matter that may have caused the fan not to function properly. • Contact SolaX for help if it can not return to normal.
IE 21	Low TempFault	<p>Low temperature fault</p> <ul style="list-style-type: none"> • Check if the ambient temperature is too low. • Contact SolaX for help if it can not return to normal.
IE 25	InterComFault	<p>Internal communication fault</p> <ul style="list-style-type: none"> • Restart the inverter. • Contact SolaX for help if it can not return to normal.

Error Code	Fault	Diagnosis and Solutions
IE 26	INV EEPROM	Inverter EEPROM fault <ul style="list-style-type: none"> • Shut down photovoltaic, battery and grid, reconnect. • Contact SolaX for help if it can not return to normal.
IE 27	RCD Fault	Residual current device fault <ul style="list-style-type: none"> • Check the impedance of DC input and AC output. • Disconnect PV+, PV - and batteries, reconnect. • Contact SolaX for help if it can not return to normal.
IE 28	Grid Relay Fault	Electrical relay fault <ul style="list-style-type: none"> • Disconnect PV+, PV-, grid and batteries and reconnect. • Contact SolaX for help if it can not return to normal.
IE 29	EPS(Off-grid) Relay Fault	EPS (Off-grid) relay fault <ul style="list-style-type: none"> • Disconnect PV+, PV-, grid and batteries and reconnect. • Contact SolaX for help if it can not return to normal.
IE 30	PV ConnDirFault	PV direction fault <ul style="list-style-type: none"> • Check if the PV input cables are connected in the opposite direction. • Contact SolaX for help if it can not return to normal.
IE 31	Battery Relay	Charge relay fault <ul style="list-style-type: none"> • Press the ESC key to restart the inverter. • Contact SolaX for help if it can not return to normal.
IE 32	Earth Relay	EPS (Off-grid) earth relay fault <ul style="list-style-type: none"> • Press the ESC key to restart the inverter. • Contact SolaX for help if it can not return to normal.
IE 33	ParallelFault	Parallel fault <ul style="list-style-type: none"> • Check the communication and earth cable connection and matching resistor settings. • Contact SolaX for help if it can not return to normal.
IE 36	HardLimitFault	Hard Limit fault <ul style="list-style-type: none"> • Check the power value set in the HardLimit setting, increase the value larger if needed. • Contact SolaX for help if it can not return to normal.

Error Code	Fault	Diagnosis and Solutions
IE 37	CTMeterConFault	<p>CT Meter Con fault</p> <ul style="list-style-type: none"> • Check if the CT or meter is well connected. • Contact SolaX for help if it can not return to normal.
IE 101	PowerTypeFault	<p>Power type fault</p> <ul style="list-style-type: none"> • Upgrade the software and press the ESC key to restart the inverter. • Contact SolaX for help if it can not return to normal.
IE 102	Port OC Warning	<p>EPS (Off-grid) port overcurrent fault</p> <ul style="list-style-type: none"> • Check if the EPS (Off-grid) load exceeds the system requirements, and press the ESC key to restart the inverter. • Contact SolaX for help if it can not return to normal.
IE 103	Mgr EEPROM Fault	<p>Manager EEPROM fault</p> <ul style="list-style-type: none"> • Shut down photovoltaic ,battery and grid, and then reconnect. • Contact SolaX for help if it can not return to normal.
IE 105	NTC Sample Invalid	<p>NTC invalid</p> <ul style="list-style-type: none"> • Make sure the NTC is properly connected and the NTC is in good condition. • Confirm that the installation environment is normal. • Contact SolaX for help if it can not return to normal.
IE 106	Bat Temp Low	<p>Battery temperature low</p> <ul style="list-style-type: none"> • Check the battery installation environment to ensure good heat dissipation. • Check if the battery heat function is enabled on the LCD screen of inverter and the heating time period is correctly set. • Contact SolaX for help if it can not return to normal.
IE 107	Bat Temp High	<p>Battery temperature high</p> <ul style="list-style-type: none"> • Check the battery installation environment to ensure good heat dissipation. • Contact SolaX for help if it can not return to normal.

Error Code	Fault	Diagnosis and Solutions
IE 109	Meter Fault	<p>Meter fault</p> <ul style="list-style-type: none"> • Check if the meter is normal and is compatible with the inverter. • Check if the communication cable is normal and properly connected. • Check if the communication settings such as protocol, address and baud rate of the meter are consistent with those of the inverter. • Contact SolaX for help if it can not return to normal.
IE 110	BypassRelayFlt	<p>Bypass relay fault</p> <ul style="list-style-type: none"> • Press the ESC key to restart the inverter. • Contact SolaX for help if it can not return to normal.
IE 111	ARMParaComFlt	<p>ARM parameter communication fault</p> <ul style="list-style-type: none"> • Check that the communication cables of inverters are well connected and the baud rate of COMM setting of inverters are the same. • Contact SolaX for help if it can not return to normal.
IE 112	FAN1 Fault	<p>FAN1 fault</p> <ul style="list-style-type: none"> • Check if the foreign objects stuck in the fan. • Change the fan. • Contact SolaX for help.
IE113	FAN2 Fault	<p>FAN2 fault</p> <ul style="list-style-type: none"> • Check if the foreign objects stuck in the fan. • Change the fan. • Contact SolaX for help.
BE 01	BMS_Exter_Err	<p>Battery error - external communication fault</p> <ul style="list-style-type: none"> • Contact the battery supplier for help.
BE 02	BMS_InterErr	<p>Battery error - internal communication fault</p> <ul style="list-style-type: none"> • Contact the battery supplier for help.
BE 03	BMS_OverVolt	<p>Over voltage in battery system</p> <ul style="list-style-type: none"> • Contact the battery supplier for help.
BE 04	BMS_LowerVolt	<p>Low voltage in battery system</p> <ul style="list-style-type: none"> • Contact the battery supplier for help.
BE 05	BMS_ChargeOCP	<p>Battery fault - over charge fault</p> <ul style="list-style-type: none"> • Contact the battery supplier for help.
BE 06	DischargeOCP	<p>Battery fault-discharge over current fault</p> <ul style="list-style-type: none"> • Contact the battery supplier for help.

Error Code	Fault	Diagnosis and Solutions
BE 07	BMS_TemHigh	Over temperature in battery system <ul style="list-style-type: none"> • Contact the battery supplier for help.
BE 08	BMS_TempLow	Battery temperature sensor malfunction <ul style="list-style-type: none"> • Contact the battery supplier for help.
BE 09	CellImblance	Battery Unbalanced Fault <ul style="list-style-type: none"> • Contact the battery supplier for help.
BE 10	BMS_Hardware	Battery hardware protection fault <ul style="list-style-type: none"> • Contact the battery supplier for help.
BE 11	BMS_Circuit	Battery circuit fault <ul style="list-style-type: none"> • Restart the battery. • Contact the battery supplier for help.
BE 12	BMS_ISO_Fault	Battery insulation fault <ul style="list-style-type: none"> • Check that the battery is properly grounded and restart the battery. • Contact the battery supplier for help.
BE 13	BMS_VolSen	Battery voltage sensor fault <ul style="list-style-type: none"> • Contact the battery supplier for help.
BE 14	BMS_TempSen	Temperature sensor fault <ul style="list-style-type: none"> • Restart the battery. • Contact the battery supplier for help.
BE 15	BMS_CurSen	Battery current sensor fault <ul style="list-style-type: none"> • Contact the battery supplier for help.
BE 16	BMS_Relay	Battery relay fault <ul style="list-style-type: none"> • Contact the battery supplier for help.
BE 17	TypeUnmatch	Battery type fault <ul style="list-style-type: none"> • Upgrade the battery BMS software. • Contact the battery supplier for help.
BE 18	Ver Unmatch	Battery version mismatch fault <ul style="list-style-type: none"> • Upgrade the battery BMS software. • Contact the battery supplier for help.
BE 19	MFR Unmatch	Battery manufacturer mismatch fault <ul style="list-style-type: none"> • Upgrade the battery BMS software. • Contact the battery supplier for help.
BE 20	SW Unmatch	Battery hardware and software mismatch fault <ul style="list-style-type: none"> • Upgrade the battery BMS software. • Contact the battery supplier for help.
BE 21	M&S Unmatch	Battery master slave control mismatch fault <ul style="list-style-type: none"> • Upgrade the battery BMS software. • Contact the battery supplier for help.

Error Code	Fault	Diagnosis and Solutions
BE 22	CR NORespond	Battery charging request no respond <ul style="list-style-type: none"> • Upgrade the battery BMS software. • Contact the battery supplier for help.
BE 23	BMS SW Protect	Battery slave software protection failure <ul style="list-style-type: none"> • Upgrade the battery BMS software. • Contact the battery supplier for help.
BE 24	BMS 536 Fault	Battery discharge over current fault <ul style="list-style-type: none"> • Contact the battery supplier for help.
BE 25	BMS SelfCheck	Over temperature in battery system <ul style="list-style-type: none"> • Contact the battery supplier for help.
BE 26	BMS Tempdiff	Battery temperature sensor malfunction <ul style="list-style-type: none"> • Contact the battery supplier for help.
BE 27	BMS_BreakFault	Battery unbalanced fault <ul style="list-style-type: none"> • Contact the battery supplier for help.
BE 28	BMS_FlashFault	Battery hardware protection failure <ul style="list-style-type: none"> • Contact the battery supplier for help.
BE 29	BMS_Precharge	Battery precharge fault <ul style="list-style-type: none"> • Contact the battery supplier for help.
BE 30	AirSwitchBreaker	Battery air switch fault <ul style="list-style-type: none"> • Check if the battery breaker is off. • Contact the battery supplier for help.
/	Screen not on	<ul style="list-style-type: none"> • Check if the inverter correctly and normally connected to PV, battery or grid. • Contact SolaX for help if the inverter is connected correctly.
	Abnormal sound on fan	<ul style="list-style-type: none"> • Check if there is foreign objects stuck in the fan. • Contact SolaX for help.
/	Screen on but no content display	<ul style="list-style-type: none"> • Contact SolaX for help.
/	LCD screen stuck in Wait state	Check if the input voltage of battery or PV is greater than 180 V. <ul style="list-style-type: none"> • If it meets the requirement, contact SolaX for help. • If the input voltage of battery or PV is less than 180 V, check the corresponding connection.
/	No readings after CT connection	<ul style="list-style-type: none"> • Check if CT is correctly clipped on the L wire • Check if the arrow on the CT points at Grid. • Contact SolaX for help if it can not return to normal.

Error Code	Fault	Diagnosis and Solutions
/	No readings on Load (on App or Web)	<ul style="list-style-type: none"> • Check if the load is connected correctly. • Check if the power of load on the LCD screen displays normally. • Check if the monitoring module works normally. • Contact SolaX for help if it can not return to normal.
/	No readings on Grid (on App or Web)	<ul style="list-style-type: none"> • Check if the grid connection is normal. • Check if the grid parameter on the LCD screen displays normally. • Check if the monitoring module works normally. • Contact SolaX for help if it can not return to normal.
/	No readings on battery (on App or Web)	<ul style="list-style-type: none"> • Check if the battery is connected correctly. • Check if the battery parameter on the LCD screen displays normally. • Check if the monitoring module works normally. • Contact SolaX for help if it can not return to normal.
/	No Feedin data (on App or Web)	<ul style="list-style-type: none"> • Check if the meter/CT is connected correctly. • Check if the meter/CT parameter on the LCD screen displays normally. • Check if the monitoring module works normally. • Contact SolaX for help if it can not return to normal.
/	No data on App or Web	<ul style="list-style-type: none"> • Check if the monitoring module works normally. • Contact SolaX for help.
/	No display on meter after power on	<ul style="list-style-type: none"> • If the meter connection is abnormal, reconnect them according to the wiring diagrams. • Wait for the grid voltage to restore. • Contact SolaX for help if it can not return to normal.

12.3 Maintenance

Regular maintenance is required for the inverter. Please check and maintain the following items based on the instructions below to ensure the optimal performance of the inverter. For inverters working in inferior conditions, more frequent maintenance is required. Please keep maintenance records.



- Only qualified person can perform the maintenance for the inverter.
- Only spare parts and accessories authorized by SolaX can be used for maintenance.

12.3.1 Maintenance Routines

Table 12-2 Proposal of Maintenance

Item	Check notes	Maintenance interval
Fans	<ul style="list-style-type: none"> • Check if the fan makes noise or is covered by dust. • Clean the fan with a soft and dry cloth or brush, or replace the fan if necessary. 	Every 12 months
Electrical connection	<ul style="list-style-type: none"> • Ensure that all cables are firmly connected. • Check the integrity of the cables, ensuring that there are no scratches on the parts touching the metallic surface. • Verify that the sealing caps on idle terminals are not falling off. 	Every 12 months
Grounding reliability	<ul style="list-style-type: none"> • Check if the grounding cables are firmly connected to the grounding terminals. Use a ground resistance tester to test the grounding resistance from the inverter enclosure to the PE bar in the power distribution box. 	Every 12 months
Heat sink	<ul style="list-style-type: none"> • Check if there are foreign objects in the heat sink. 	Every 12 months
General status of inverter	<ul style="list-style-type: none"> • Check if there is any damage on the inverter. • Check if there is any abnormal sound when the inverter is running. 	Every 6 months

12.3.2 Upgrading Firmware

WARNING!

- Make sure that the type and format of the firmware file are correct. Do not modify the file name. Otherwise, the inverter may not work properly.
- Do not modify the folder name and file path where the firmware files are located, as this may cause the upgrade to fail.

WARNING!

- Before upgrading, ensure that the PV input voltage is higher than 180 V (preferably on sunny day), or that the battery SOC is higher than 20%, or the battery input voltage is higher than 180 V. Failure to meet one of these conditions may result in upgrade process failure.

WARNING!

- When upgrading firmware including ARM, please give priority to upgrading the ARM program.

Upgrade preparation

- Prepare a USB drive (USB 2.0/3.0, FAT16 supports up to 2GB; FAT32 supports up to 2TB).
- Check for the current firmware version of the inverter.
- Contact our service support for the update firmware file, and save it to the USB drive.
 - » For ARM file: XXX.XXXXX.XX_HYB_3P_ARM_VXXX.XX_XXXX.usb
 - » For DSP file: XXX.XXXXX.XX_HYB_3P_DSP_VXXX.XX_XXXX.usb

Upgrade steps

- Press and hold the **Enter** key on the inverter LCD for 5 seconds to enter the **OFF** mode.
- Remove the dongle from the Dongle terminal of the inverter by hand, and then insert the USB drive. The inverter will automatically display the **Upgrade Selection** interface. (For the position of Dongle terminal, see ["8.1.1 Terminals and Parts of Inverter"](#).)
- On the **Upgrade Selection** interface, select **ARM** or **DSP** based on the file type, and then tap **OK**.

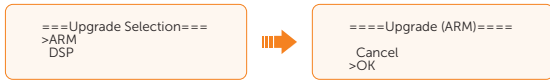

- d. Select and confirm the firmware version, and then tap the **Enter** key to start updating. ARM update takes about 20 seconds, and DSP update takes about 2 minutes.

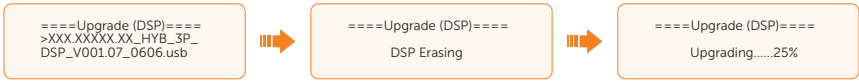
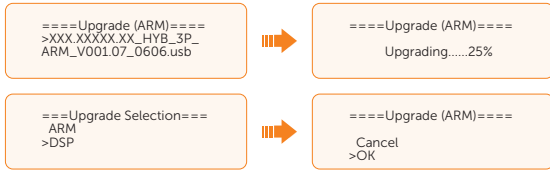

- e. After the upgrade is completed, the LCD screen displays **Upgrade Successful**. If the upgrades fail, the LCD screen displays **Upgrade failed**.

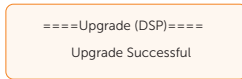

- f. Unplug the USB drive and press **ESC** to return to the main interface.

CAUTION!

- If the ARM firmware upgrade fails or stops, do not unplug the USB drive. Power off the inverter, restart it, and then repeat the above upgrade steps.

CAUTION!

If the DSP firmware upgrade fails or stops, perform operations below to troubleshoot:

- Check if the DC switch is turned off. If it is off, turn it on.
- (Recommended) If the DC switch is already on, check if the battery and PV parameters in **Menu>System Status** meets the upgrade requirements (The PV or battery input voltage should be larger than 180 V, or the battery SOC be higher than 20%).
- Alternatively, select **Menu > Mode Select > Manual > Forced Charge** to charge the battery. This process can help wake up the battery for DSP upgrade.

NOTICE!

- If the LCD screen lags or freezes after the upgrade, turn off the DC switch, and then restart the inverter. Check if the inverter returns to normal. If not, contact us.

13 Decommissioning

13.1 Disassembling the Inverter



- Strictly follow the steps below to disassemble the inverter.
- Only use the dedicated removal tool delivered with the inverter to disassemble the PV connector.

Step 1: Turn off the system by **System ON/OFF** on LCD screen.

Step 2: Disconnect the external AC breaker of the inverter.

Step 3: Turn the DC switch to OFF. For how to turn off lockable DC switch, see "[9.4 Operation of Lockable DC Switch](#)".

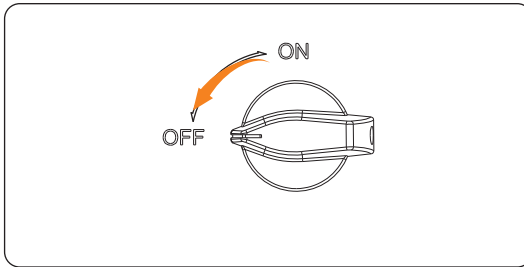

Figure 13-1 Turning off the DC switch

Step 4: Turn off the battery switch / button / breaker (if any). (See documents of battery)

Step 5: Disconnect the PV connectors: Insert the removal tool into the notch of PV connectors and slightly pull out the connectors.

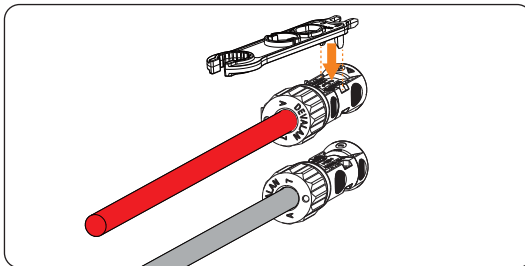

Figure 13-2 Disconnecting the PV connector

Step 6: Disconnect the battery connectors: Insert the flat-head screwdriver into the notch of connectors and slightly pull the connectors.

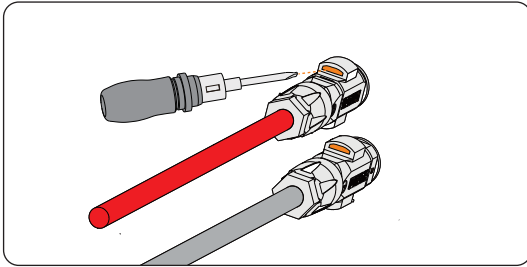

Figure 13-3 Disconnecting the battery connector

Step 7: Disconnect the AC connector: Loosen the swivel nut and the four screws on the AC protective cover; use flat-head screwdriver to loosen the screws on Grid and EPS (off-grid) connection terminal. Slight pull the connectors.

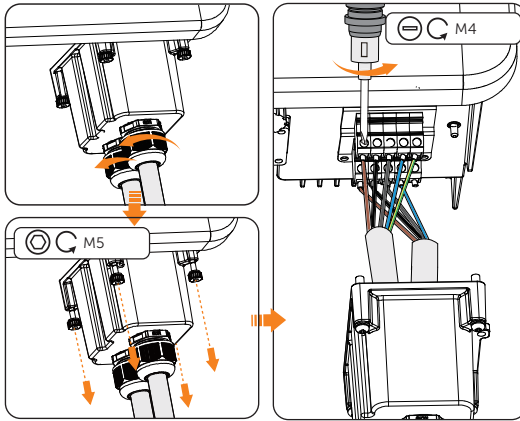

Figure 13-4 Disconnecting the AC connector

! WARNING!

- Before pulling the connectors, use multimeter to measure the AC voltage and make sure the voltage is lower than 36 Vac.

Step 8: Disconnect the COM / BMS / Meter / CT cable: Loosen the waterproof connectors and slight unplug the RJ45 terminal.

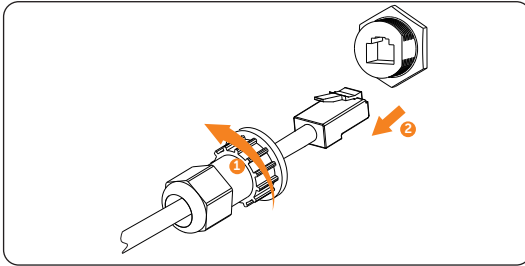

Figure 13-5 Disconnecting the COM / BMS / Meter / CT cable

Step 9: Disconnect the CAN1 / CAN2 / DRM / OFF cable: Loosen the swivel nut and four crossscrews on the cover and slight unplug the RJ45 terminal.

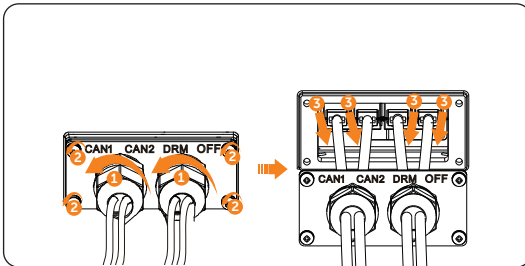

Figure 13-6 Disconnecting the CAN1 / CAN2 / DRM / OFF cable

Step 10: Slight unplug the dongle module.

Step 11: Put the original terminal caps on the terminals.

Step 12: Unscrew the grounding screw and remove the grounding cable.

Step 13: Unlock the anti-theft lock if you installed it. Unscrew the M5 screw on the side of inverter and vertically lift up the inverter to dismantle the inverter.

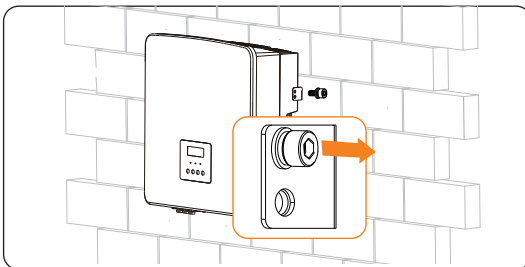

Figure 13-7 Unscrewing the M5 screws

Step 14: Unscrew the screws for fastening the bracket and remove the bracket if needed.

13.2 Packing the Inverter

- Use the original packaging materials if available.

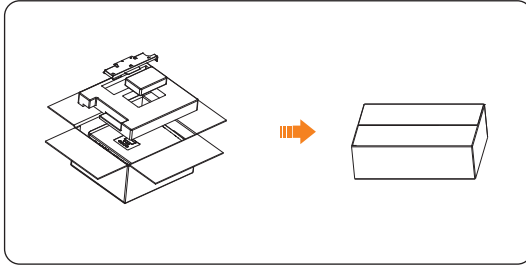

Figure 13-8 Packing the inverter

- If the original packing material is not available, use the packing material which meets the following requirements:
 - » Suitable for the weight and dimension of product
 - » Convenient for transportation
 - » Can be sealed with adhesive tape

13.3 Disposing of the Inverter

Properly dispose of the inverter and accessories in accordance with local regulations on the disposal of electronic waste.

14 Technical Data

• DC Input

Model	X3-Hybrid-5.0-D	X3-Hybrid-6.0-D	X3-Hybrid-8.0-D	X3-Hybrid-10.0-D X3-Hybrid-10.0K-D	X3-Hybrid-12.0-D X3-Hybrid-12.0K-D	X3-Hybrid-15.0-D	X3-Hybrid-5.5-D LV	X3-Hybrid-8.3-D LV
Max. PV voltage [d.c. V]	1000	1000	1000	1000	1000	1000	800	800
Nominal DC operating voltage [d.c. V]	640	640	640	640	640	640	360	360
MPPT voltage range [d.c. V]	180-950	180-950	180-950	180-950	180-950	180-950	160-650	160-650
Max. PV current [d.c. A]	16/16	16/16	28*/16	28*/16	28*/16	28*/16	28*/16	28*/16
Isc PV array short circuit current [d.c. A]	20/20	20/20	35/20	35/20	35/20	35/20	35/20	35/20
Max. inverter backfeed current to the array	0	0	0	0	0	0	0	0
Start output voltage [d.c. V]	200	200	200	200	200	200	200	200
No. of MPPT trackers	2	2	2	2	2	2	2	2
Strings per MPPT tracker	A:1/B:1	A:1/B:1	A:2/B:1	A:2/B:1	A:2/B:1	A:2/B:1	A:2/B:1	A:2/B:1

* The max. current when the PV 1 side connects to two PV panels: When the PV1 side only connects to one PV panel, the max. current is 20A.

• AC Output

Model	X3-Hybrid-5.0-D	X3-Hybrid-6.0-D	X3-Hybrid-8.0-D	X3-Hybrid-10.0-D X3-Hybrid-10.0K-D	X3-Hybrid-12.0-D X3-Hybrid-12.0K-D	X3-Hybrid-15.0-D	X3-Hybrid-5.5-D LV	X3-Hybrid-8.3-D LV
Rated output apparent power [VA]	5000 (4999 for AS/NZS 4777.2)	6000	8000	10000 (10.0K-D 9999) (9999 for AS/NZS 4777.2)	12000 (12.0K-D 11999)	15000 (PEA 14000) (14999 for AS/NZS 4777.2)	5500	8300
Max. output apparent power [VA]	5500 (4999 for AS/NZS 4777.2)	6600	8800	11000 (10.0K-D 9999) (9999 for AS/NZS 4777.2)	13200 (12.0K-D 11999)	15000 (14999 for AS/NZS 4777.2)	6100	8300
Nominal AC voltage [a.c. V]	415/240; 400/230; 380/220						127	
Nominal AC frequency [Hz]	50/60						50/60	
Max. output continuous current [a.c. A]	8.1	9.7	12.9	16.1	19.3	24.1	16.1	21.8

Technical Data

Model	X3-Hybrid- 5.0-D	X3-Hybrid- 6.0-D	X3-Hybrid- 8.0-D	X3-Hybrid- 10.0-D X3-Hybrid- 10.0K-D	X3-Hybrid- 12.0-D X3-Hybrid- 12.0K-D	X3-Hybrid- 15.0-D	X3-Hybrid- 5.5-D LV	X3-Hybrid- 8.3-D LV
Current (inrush)(at 50 µs) [a.c. A]	30							
Rated output current [a.c. A]	7.2	8.7	11.6	14.5	17.5	21.8	14.5	21.8
Power factor range	1 (0.8 leading ... 0.8 leading)							
Total harmonic distortion (THDi)	< 3%							
Maximum output fault current (at 5ms) [a.c. A]	68							
Maximum output overcurrent protection [a.c. A]	68							
Rated AC input power [W]	10000	12000	16000	20000	20000	20000	11000	12100
Max. AC input apparent power [W]	10000	12000	16000	20000	22000	22000	11000	12100
Nominal AC voltage [a.c. V]	415/240; 400/230; 380/220						127	
Nominal AC frequency [Hz]	50/60						50/60	
Max. AC current [a.c. A]	16.1	19.3	25.8	32.0	32.0	32.0	32.0	32.0

- Battery

Model	X3-Hybrid- 5.0-D	X3-Hybrid- 6.0-D	X3-Hybrid- 8.0-D	X3-Hybrid- 10.0-D X3-Hybrid- 10.0K-D	X3-Hybrid- 12.0-D X3-Hybrid- 12.0K-D	X3-Hybrid- 15.0-D	X3-Hybrid- 5.5-D LV	X3-Hybrid- 8.3-D LV
Battery type	Lithium-ion battery / Lead-acid battery							
Battery voltage range [d.c. V]	120-800*						180-650	
Max. continuous charge/discharge current [d.c. A]	30 A							
Communication interface	CAN/RS485							
Reverse connection protection	Yes							

*Compatible with a minimum of 3 units of HS25/HS36 batteries, but if the total voltage of the 3 batteries is less than 127V and there is no PV input, the system will be not able to start.

• Efficiency, Safety and Protection

Model	X3-Hybrid-5.0-D	X3-Hybrid-6.0-D	X3-Hybrid-8.0-D	X3-Hybrid-10.0-D X3-Hybrid-10.0K-D	X3-Hybrid-12.0-D X3-Hybrid-12.0K-D	X3-Hybrid-15.0-D	X3-Hybrid-5.5-D LV	X3-Hybrid-8.3-D LV
MPPT efficiency	99.9%	99.9%	99.9%	99.9%	99.9%	99.9%	99.9%	99.9%
European efficiency	97.7%	97.7%	97.7%	97.7%	97.7%	97.7%	97.7%	97.7%
Maximum efficiency	98.0%	98.0%	98.0%	98.0%	98.0%	98.0%	98.0%	98.0%
Max. battery charge efficiency (PV to BAT)(@ full load)	98.5%	98.5%	98.5%	98.5%	98.5%	98.5%	98.5%	98.5%
Max. battery discharge efficiency (BAT to AC)(@ full load)	97.5%	97.5%	97.5%	97.5%	97.5%	97.5%	97.5%	97.5%
Security & Protection								
Safety	EN / IEC 62109-1 / -2							
Grid monitoring	VDE4105, G99, G98, AS4777, EN50549, CEI 0-21, IEC61727, PEA / MEA, NRS-097-2-1, RD1699, TOR							
DC SPD protection	Integrated							
AC SPD protection	Integrated							
Over/under voltage protection	Yes							
Grid protection	Yes							
DC injection monitoring	Yes							
Back feed current monitoring	Yes							
Residual current detection	Yes							
Active anti-islanding method	Frequency Shift							
Over load protection	Yes							
Over heat protection	Yes							
Array insulation resistance detection	Yes							

Technical Data

- EPS (Off-grid) Output

Model	X3-Hybrid- 5.0-D	X3-Hybrid- 6.0-D	X3-Hybrid- 8.0-D	X3-Hybrid- 10.0-D X3-Hybrid- 10.0K-D	X3-Hybrid- 12.0-D X3-Hybrid- 12.0K-D	X3-Hybrid- 15.0-D	X3-Hybrid- 5.5-D LV	X3-Hybrid- 8.3-D LV
EPS(Off-grid) rated power [VA]	5000	6000	8000	10000	12000	15000	5500	8300
EPS(Off-grid) rated voltage [a.c. V]	400/230			220/127				
Frequency [Hz]	50/60			50/60				
EPS(Off-grid) rated current [a.c. A]	7.2	8.7	11.6	14.5	17.5	21.8	14.5	21.8
EPS(Off-grid) peak power [VA]	12000,10s	12000,10s	18000,10s	18000,10s	22500,10s	22500,10s	9900,10s	12400,10s
Switching time [ms]	< 10 ms							
Total harmonic distortion (THDv)	< 3%							

- Generic Data

Model	X3-Hybrid- 5.0-D	X3-Hybrid- 6.0-D	X3-Hybrid- 8.0-D	X3-Hybrid- 10.0-D X3-Hybrid- 10.0K-D	X3-Hybrid- 12.0-D X3-Hybrid- 12.0K-D	X3-Hybrid- 15.0-D	X3-Hybrid- 5.5-D LV	X3-Hybrid- 8.3-D LV
Dimensions (W/H/D)[mm]	503 * 503 * 199							
Dimensions of packing (W/H/D)[mm]	560 * 625 * 322							
Net weight [kg]	30±1	30±1	30±1	30±1	30±1	30±1	30±1	30±1
Gross weight * [kg]	34±1	34±1	34±1	34±1	34±1	34±1	34±1	34±1
Heat dissipation treatment	Natural Cooling				Smart Cooling		Natural Cooling	Smart Cooling
Noise emission(typical) [dB]	< 35				<45		< 40	<45
Storage temperature range [°C]	-40 to +70							
Operating ambient temperature range [°C]	-35 to +60 (derating at 45)							
Humidity [%]	4%-100% (condensing)							
Altitude [m]	< 3000							
Ingress protection	IP65							
Protective class	I							
Cold standby consumption	< 5W							
Overvoltage category	III (MAINS), II (PV, Battery)							
Pollution degree	III							
Installation mode	Wall-mounted							
Inverter topology	Non-isolated							
Communication interface	CT / Meter (optional), External control RS485, Pocket WiFi (Optional: Pocket Lan / 4G), DRM, USB Upgrade, NTC (optional)							

* The specific gross weight is subject to the actual situation of the whole machine.

15 Appendix

15.1 Application of Generator

15.1.1 Introduction of Generator Application

In the event of a power outage, the system can seamlessly switch to the generator for power supply and continue the collaboration with the energy storage system to ensure the uninterrupted operation of the load.

In this case, the generator functions as the utility grid to supply power for the load, and the hybrid inverter converts the solar energy to electricity.

15.1.2 Notice for Generator Application

- Note 1: The generator should be equipped with an Automatic Transfer Switching Equipment (ATS), enabling it to start automatically or control the generator start by parameter setting in the event of a power outage.
- Note 2: The rated output power of the generator should be greater than the sum of the load power and the battery charging power. If there are several inverters in parallel, the rated output power of the generator should be greater than the sum of the load power and the battery charging power of the inverters.
- Note 3: If the rated output power of the generator is small and cannot meet the requirements of Note 2, the setting value of **MaxChargePower** can be changed in the **Menu>Setting>Advance Setting>ExternalGen** to ensure that the generator power can meet the load and battery charging use at the same time.
- Note 4: The EPS (off-grid) load power cannot be greater than the battery discharge power to prevent the battery power from being unable to meet the EPS (off-grid) load after the generator shuts down and the inverter will report an **EPS Overload fault** alarm. If two inverters are paralleled, the EPS (off-grid) load power shall be doubled.

15.1.3 ATS Control Mode

In this operating mode, the generator functions as a substitute for the grid. There is no communication between the generator and the inverter, which means no wiring modifications are required (although the inverter cannot control the generator). The ATS working for the generator determines whether the generator should be turned on or off based on the status of the grid.

Wiring connection diagram

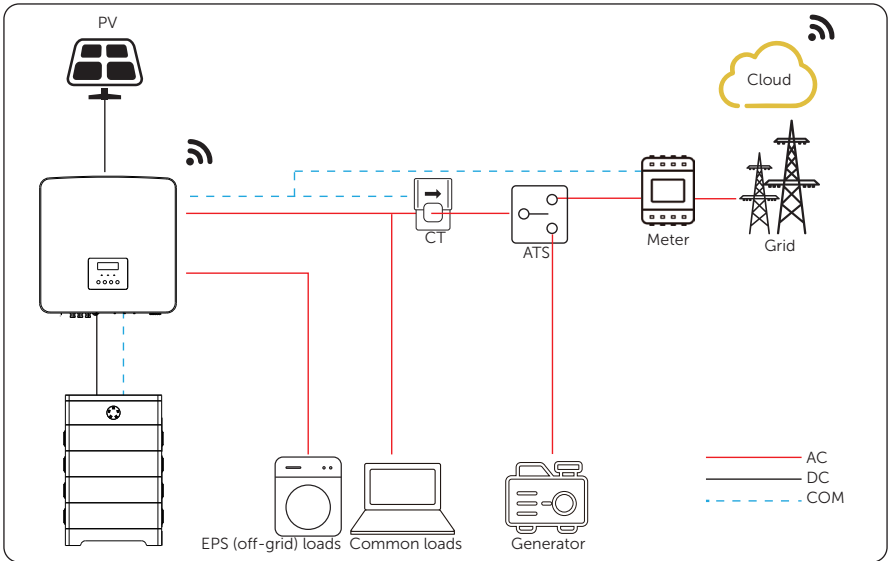

Figure 15-1 ATS control wiring diagram

Inverter settings for ATS control mode

- a. Select **Menu>Setting>Advance Setting>ExternalGen>ATS Control**.

```
====ExternalGen====
>Function Control
  ATS Control
```

- b. Set the relative parameters as below in accordance with actual needs.
 - » **MaxChargePower**: Default: 5000 W, range: 0-300000 W
Maximum battery charging power from generator.

```
====ExternalGen=====
>MaxChargePower
5000W
```

- » **Char&Disc Period:** Including **Forced Charge Period** and **Allowed Disc Period**. Two periods can be set. These period settings are associated with the same settings under working mode for no need to jump to working mode page to set the working period when using generator mode.

```
====ExternalGen=====
>Forced Charge Period
Start Time
00:00
```

```
====ExternalGen=====
>Allowed Disc Period
Start Time
00:00
```

```
====ExternalGen=====
>Forced Charge Period
End Time
00:00
```

```
====ExternalGen=====
>Allowed Disc Period
End Time
00:00
```

- » **Charge from Gen and Charge battery to:**

Charge battery to: Default: 10%; range: 10-100%

The SOC which allows the system charging from generator.

```
====ExternalGen=====
Charge from GEN
> Enable <
```



```
====ExternalGen=====
>Charge battery to
10%
```

- » **HoldGenMinPower:** Default: 0 W; range: 0-60000 W

The minimum charging power of the generator to charge the battery.

```
====ExternalGen=====
HoldGenMinPower
0 W
```

15.1.4 Dry Contact Mode

In this operating mode, users can intelligently control the system by establishing a dry contact connection between the inverter and the generator. It allows for adjustments to multiple settings so that the system can meet the requirements of different scenarios.

Wiring connection diagram

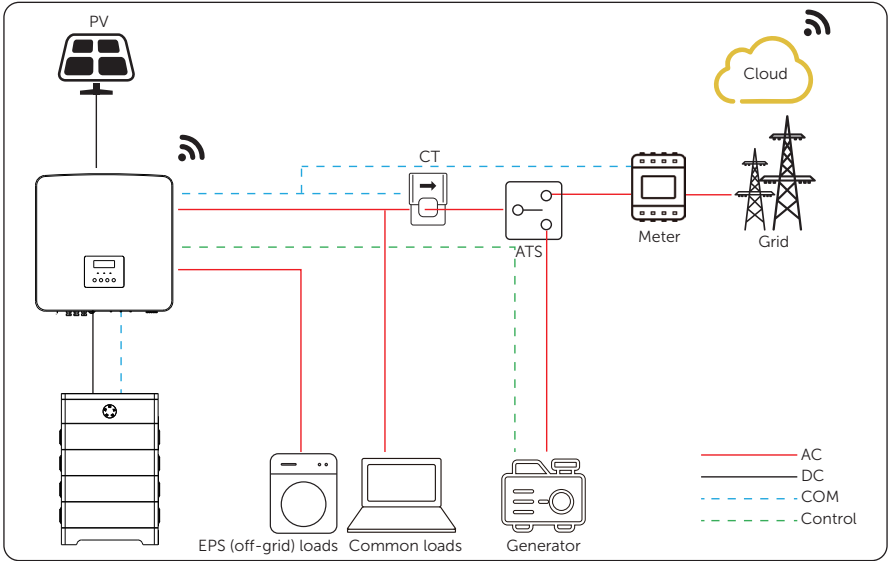

Figure 15-2 Dry contact wiring diagram

Inverter connection for dry contact mode

- Connection terminal-COM terminal

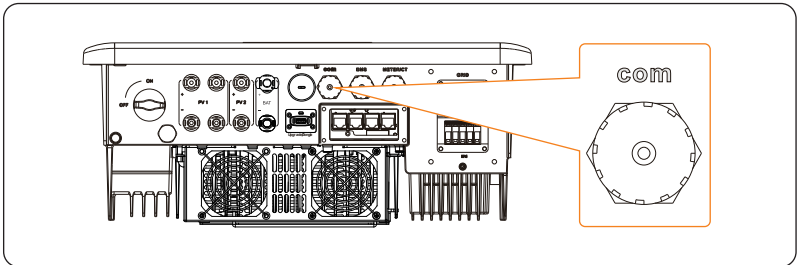

Figure 15-3 Connection terminal for generator

- Connection pins-Pin 7 and Pin 8

Table 15-1 Connection pins for generator

Pin	Assignment	Description
7	Drycontact_A(out)	For generator connection
8	Drycontact_B(out)	

- Connection steps: Please refer to "8.6.1 COM Communication Connection" for specific wire making and connection.
 - Inverter settings for dry contact mode
- a. Select **Menu>Setting>User Setting>Dry Contact>Generator**.

```
====Dry Contact====
Load Management
>Generator
```

- b. Select **Menu>Setting>Advance Setting>ExternalGen>Dry Contact**.

```
====ExternalGen====
>Function Control
Dry Contact
```

- c. Set the relative parameters in accordance with actual needs.

- » **MaxChargePower**: Default: 5000 W, range: 0-300000 W
Maximum battery charging power from generator.

```
====ExternalGen====
>MaxChargePower
5000W
```

- » **Start Gen Method: Reference SOC** and **Immediately** can be selected.
Reference SOC: Turn on/off generator according to the set **Switch on/off SOC**. **Immediately**: Turn on /off the generator when grid status changed.

```
====ExternalGen====
>Start Gen Method
Reference soc
```

```
====ExternalGen====
>Start Gen Method
Immediately
```

- » **Switch on/off SOC**: the option is activated when you select **Reference SOC** for **Start Gen Method**. The inverter will turn on the generator when the battery reaches the set **Switch on SOC** and turn it off when the battery reaches the set **Switch off SOC**.

```
====ExternalGen====
>Switch on SoC
0%
```

```
====ExternalGen====
>Switch off SoC
0%
```

- » **MaxRunTime**: Maximum operating time of generator. (1000 Min by default)

```
====ExternalGen====
>MaxRunTime
30Min
```

- » **MinRestTime:** Minimum time interval for two consecutive starts to avoid frequent generator on and off. (60 Min by default)

```
====ExternalGen====
>MaxRestTime
  0Min
```

- » **Char&Disc Period:** Including **Forced Charge Period** and **Allowed Disc Period**. Two periods can be set. These period settings are associated with the same settings under **Working mode** for no need to jump to working mode page to set the working period when using generator mode.

```
====ExternalGen====
>Forced Charge Period
  Start Time
  00:00
```

```
====ExternalGen====
>Allowed Disc Period
  Start Time
  00:00
```

```
====ExternalGen====
>Forced Charge Period
  End Time
  00:00
```

```
====ExternalGen====
>Allowed Disc Period
  End Time
  00:00
```

- » **Allow Work:** Allowed time period for generator operating. You can set the start time and end time.

```
====ExternalGen====
>Allow Work
  Start Time
  00:00
```

```
====ExternalGen====
>Allow Work
  End Time
  00:00
```

- » **Charge from Gen and Charge battery to:**

Charge battery to: Default: 10%; range: 10-100%

The SOC which allows the system charging from generator.

```
====ExternalGen====
  Charge from GEN
  > Enable <
```



```
====ExternalGen====
  >Charge battery to 10%
```

- » **HoldGenMinPower:** Default: 0 W; range: 0-60000 W

The minimum charging power of the generator to charge the battery.

```
====ExternalGen====
  HoldGenMinPower
  0 W
```

15.2 Application of Adapter Box G2

15.2.1 Introduction of Adapter Box G2 Application

With the SolaX Adapter Box G2, users can effectively utilize solar energy by commanding it to power their heat pump using settings available on the SolaX inverter and SolaXCloud. This intelligent integration allows for optimized solar self-consumption and ultimately helps in reducing electricity bills.

15.2.2 Wiring Connection Diagram

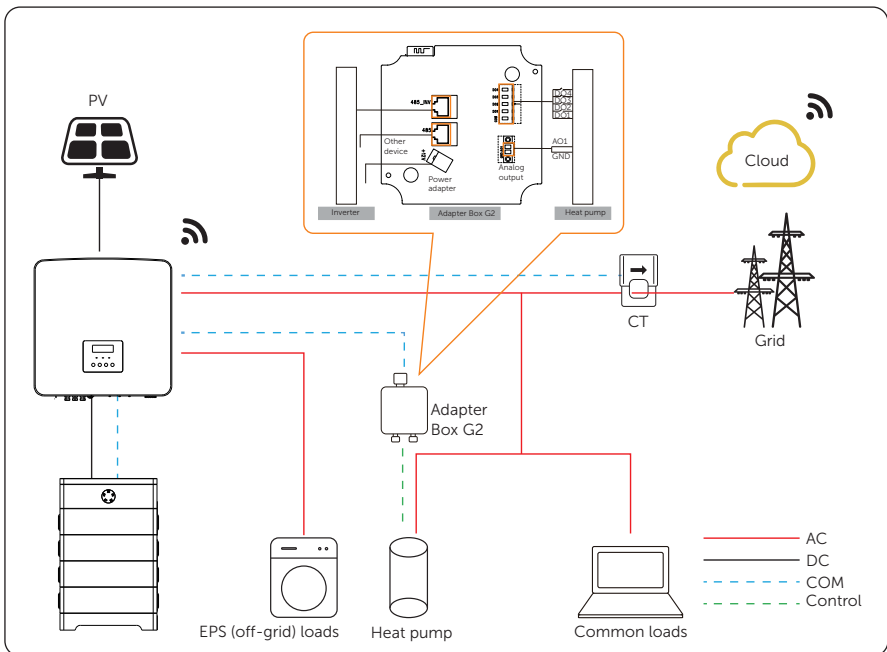

Figure 15-4 Adapter Box G2 wiring diagram

The inverter communicates with Adapter Box G2 via RS485. In case of excess power, the Adapter Box G2 can utilize it to heat the pump through the connection of dry contacts, SG Ready, or Analog output between the Adapter Box G2 and the heat pump. To power the Adapter Box G2, an external power adapter is required as the inverter itself cannot supply power to the Adapter Box G2.

15.2.3 Communication connection with inverter

- Connection terminal-COM terminal

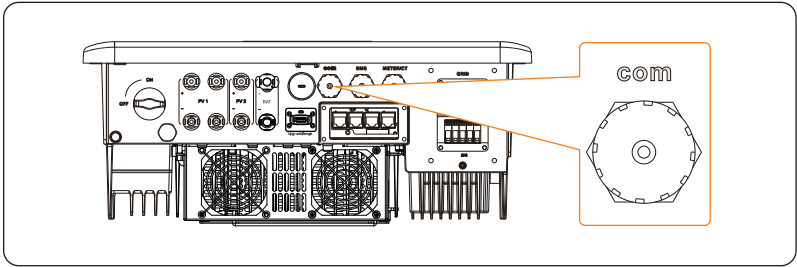

Figure 15-5 Connection terminal for Adapter Box G2

- Connection pins-Pin4 and pin 5

Table 15-2 Pin-to-pin connection for inverter and Adapter Box G2

COM terminal of inverter		RS485_INV terminal of Adapter Box G2	
Pin	Pin assignment	Pin	Pin assignment
4	485A	4	RS485-A
5	485B	5	RS485-B

- Connection steps-Please refer to "[8.6.1 COM Communication Connection](#)" for specific wire making and connection.

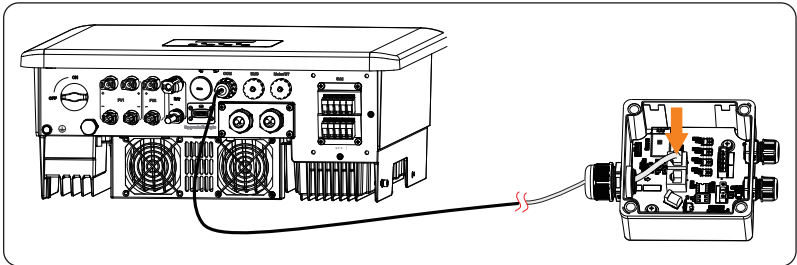

Figure 15-6 Connecting to Adapter Box G2

NOTICE!

- The communication cable between Adapter Box G2 and inverter can not exceed 30 meters.

15.2.4 Settings for Adapter Box G2

- Select **Menu>Setting>Advance Setting>Modbus**;
- Select the **AdapBox G2** and set the **Baud Rate** and corresponding Address. The default **Baud Rate** is 9600.

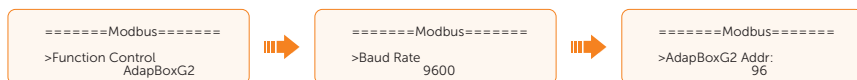

NOTICE!

- When two equipments need to be connected at the same time, the Baud rate of the two equipments shall be set to the same.

- Check the connection status.

```

=====Modbus=====
>AdapBox G2 COM STAT
  Connected
  
```

NOTICE!

- For specific wiring and setting procedures of Adapter Box G2, see Adapter Box G2 user manual.

15.3 Application of EV-Charger

15.3.1 Introduction of EV-Charger Application

The EV-Charger is intended for charging electric vehicles. It can communicate with other devices or systems (inverter, meter, CT, third-party charger management platform, etc.) to realize intelligent control of charging process.

15.3.2 Wiring Connection Diagram

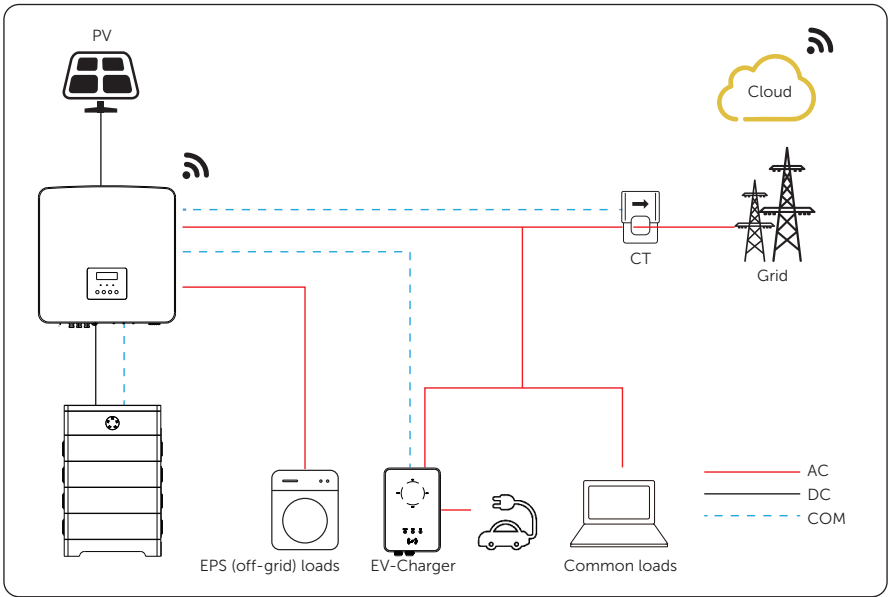

Figure 15-7 EV-Charger wiring diagram

15.3.3 Communication Connection with Inverter

- Connection terminal-COM terminal

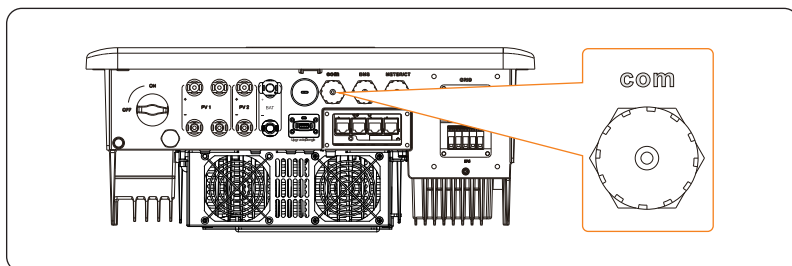

Figure 15-8 Connection terminal for EV-Charger

- Connection pins-Pin 4 and Pin 5

Table 15-3 Pin-to-pin connection for inverter and EV-Charger

COM terminal of inverter		COM terminal of EV-Charger	
Pin	Pin assignment	Pin	Pin assignment
4	485A	4	A1
5	485B	5	B1

- Connection steps-Please refer to "[8.6.1 COM Communication Connection](#)" for specific wire making and connection.

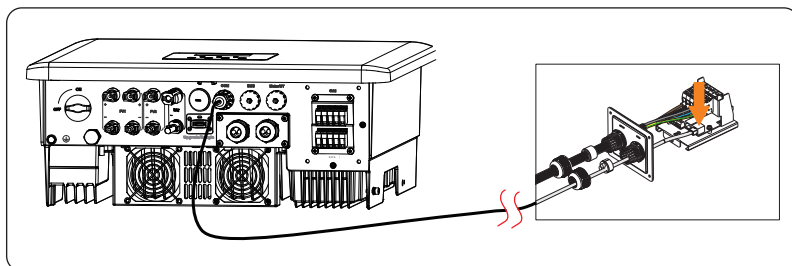

Figure 15-9 Connecting to EV-Charger

NOTICE!

- The communication cable between EV-Charger and inverter can not exceed 30 meters.
- If EV-Charger and Adapter Box G2 are connected simultaneously, please use a one to two RJ45 waterproof splitter adapter.

15.3.4 Setting for EV-Charger

- a. Select **Menu>Setting>Advance Setting>Modbus**;
- b. Select the **EV Charger** and set the **Baud Rate** and corresponding Address. The default **Baud Rate** is 9600.

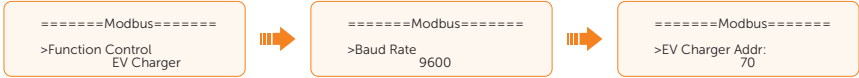

NOTICE!

- When EV-Charger and other communication device need to be connected at the same time, the Baud rate of the two equipments shall be set to the same.

- c. Check the connection status.

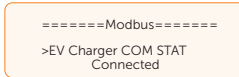

- d. You can enable **Battery Charge EVC** to allow the battery to discharge energy to EV-Charger through setting path: **Menu>Setting>Advance Setting>Battery Charge EVC**.

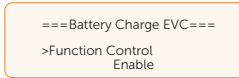

NOTICE!

- For specific wiring and setting procedures of EV-Charger, see X1/X3-EVC series user manual.

15.4 Application of DataHub

15.4.1 Introduction of DataHub Application

SolaX DataHub can be connected to inverters through RS485 to control the output power of the entire power station according to on-site requirements. Besides, it can work with SolaXCloud to monitor all inverters, allowing for real-time data display and device management. In the entire system, a maximum of 60 X3-Hybrid G4 series inverters can be connected to the DataHub.

15.4.2 Wiring Connection Diagram

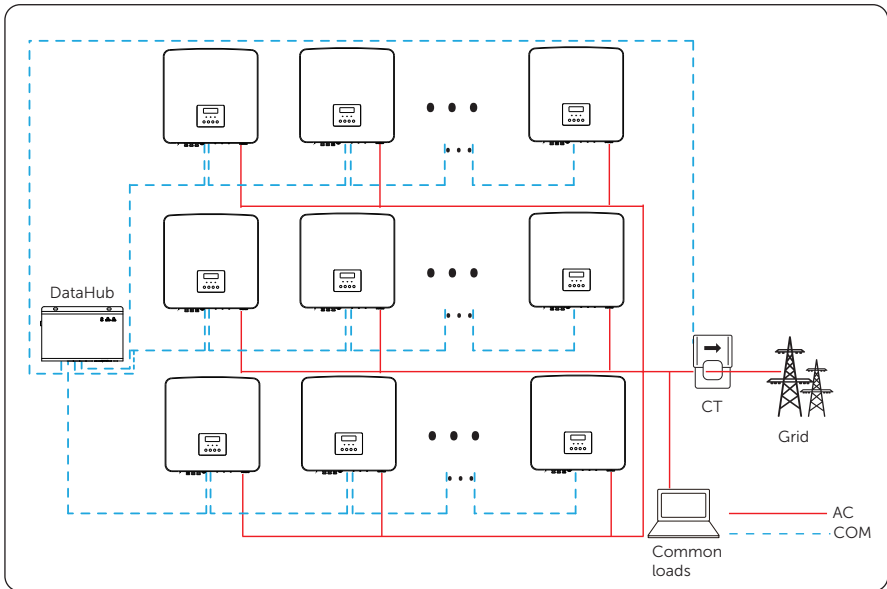

Figure 15-10 DataHub wiring diagram

15.4.3 Communication Connection with Inverter

- Connection terminal-COM terminal

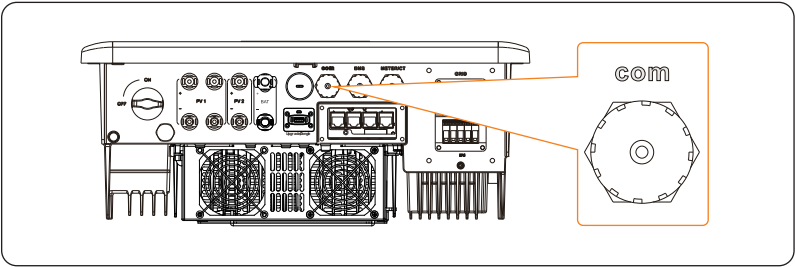

Figure 15-11 Connection terminal for DataHub

- Connection pins-Pin 4 and Pin 5

Table 15-4 Pin-to-pin connection for inverter and DataHub

COM terminal of inverter		RS485-1/-2/-3/-4 terminal of DataHub	
Pin	Pin assignment	Pin	Pin assignment
4	485A	/	A+
5	485B	/	B-

- Connection steps-Please refer to "8.6.1 COM Communication Connection" for specific wire making and connection.

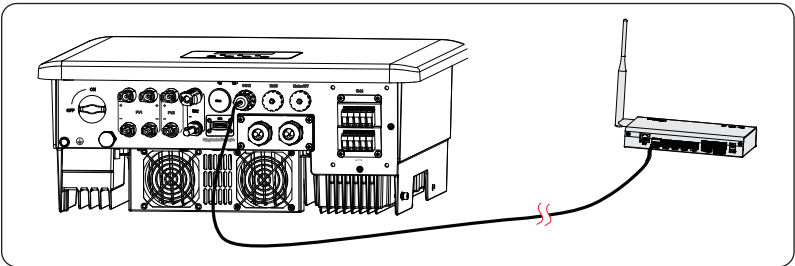

Figure 15-12 Connecting to DataHub

NOTICE!

- The communication cable between DataHub and inverter can not exceed 30 meters.

15.4.4 Settings for DataHub

- a. Select **Menu>Setting>Advance Setting>Modbus**;
- b. Select the **DataHub** and set the **Baud Rate** and corresponding Address.

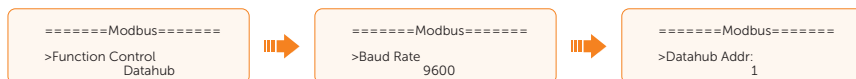

NOTICE!

- The baud rate, communication protocol and verification method of the inverters connected to the same RS485 terminal of DataHub must be consistent, and the communication addresses of the inverters must be consecutive and not repeated.

NOTICE!

- For specific wiring and setting procedures of DataHub, see DataHub 1000 user manual.

15.5 Application of Parallel Function

15.5.1 Introduction of Parallel Application

The series inverters supports parallel operation in both Grid and EPS (off-grid) modes. It can be configured with SolaX X3-PBOX-150kW-G2, X3-PBOX-60 kW-G2. Without X3-PBOX device, it supports up to 3 units in the parallel system, while with X3-PBOX-150kW-G2, it supports up to 10 units; with X3-PBOX-60kW-G2, it supports up to 6 units.

* Up to 10 inverters can be connected in parallel when there is no EPS (off-grid) connection.

15.5.2 Notice for Parallel Application

- All inverters should be of the same software version.
- For optimal efficiency, it is recommended that all inverters have the same model, and are connected to batteries of the same model and quantity.
- In parallel system, there are three states: **Free**, **Slave** and **Master**.

Table 15-5 Three states

Free	Only if no one inverter is set as a Master , all inverters are in Free mode in the system.
Slave	Once one inverter is set as a Master , all other inverters will enter Slave mode automatically. Slave mode can not be changed from other modes by LCD setting.
Master	When one inverter is set as a Master , this inverter enters Master mode. Master mode can be changed to Free mode.

- Master inverter has an absolute lead in the parallel system to control all slave inverter's energy management and dispatch control. Once master inverter has some error and stop working, all slave inverters will be stop simultaneously. But master inverter is independent of all slave inverters to work and will not be affected by slave inverter's fault.
- Overall system will be running according to master inverter's setting parameters, and most setting parameters of slave inverter will be kept but not be cancelled.
- Once slave inverter exits from the system and be running as an independent unit (the network cable is disconnected simultaneously), its all setting will be re-activated.
- The parallel system is extremely complex and requires a large number of cables to be connected. Therefore, the cables must be connected in the correct wire sequence. Otherwise, any small mistake can lead to system failure.
- The communication cables between the CAN1 and CAN2 terminals of different inverters in parallel connection and between the COM terminal of the X3-PBOX device and the CAN1 terminal of the master inverter is no more than 3 meters.

15.5.3 System Wiring Diagram

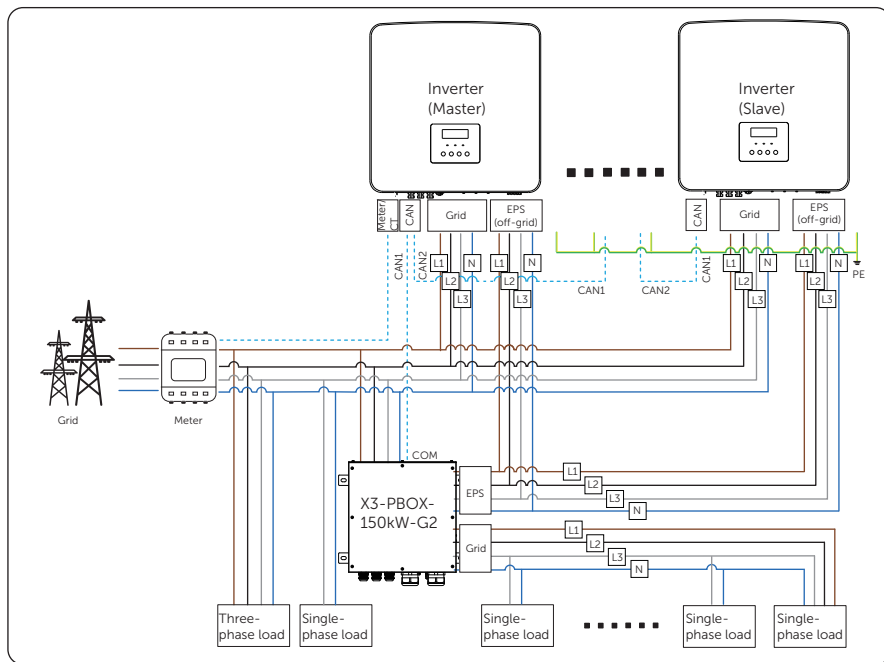

Figure 15-13 With X3-PBOX-150kW-G2 system wiring diagram

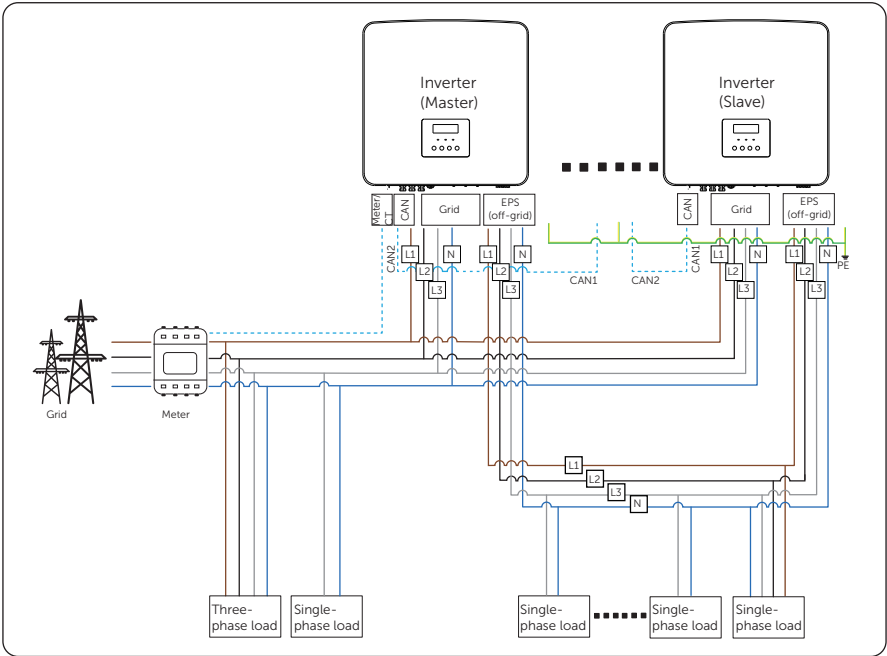

Figure 15-14 Without X3-PBOX-150kW-G2 system wiring diagram

NOTICE!

- In the parallel system without X3-PBOX-150kW-G2 and X3-PBOX-60kW-G2, make sure that **External ATS** in the setting path of **Menu>Setting>Advance Setting>External ATS** is disabled.

15.5.4 System Wiring Procedure

With X3-PBOX device

- Power cable wiring procedure:
 - a. User five-core copper cable (for grid connection) and four-core copper cable (for EPS (off-grid) connection) to connect Master-Slave inverter and Master-X3-PBOX device.
 - b. Grid connection terminal of Master, Slave inverter and X3-PBOX device: L1 connects to L1, L2 connects to L2, L3 connects to L3 and N connects to N.
 - c. EPS (off-grid) connection terminal of Master, Slave inverter and X3-PBOX device: L1 connects to L1, L2 connects to L2, L3 connects to L3 and N connects to N.
 - d. All PE cable connects to the E-BAR nearby.

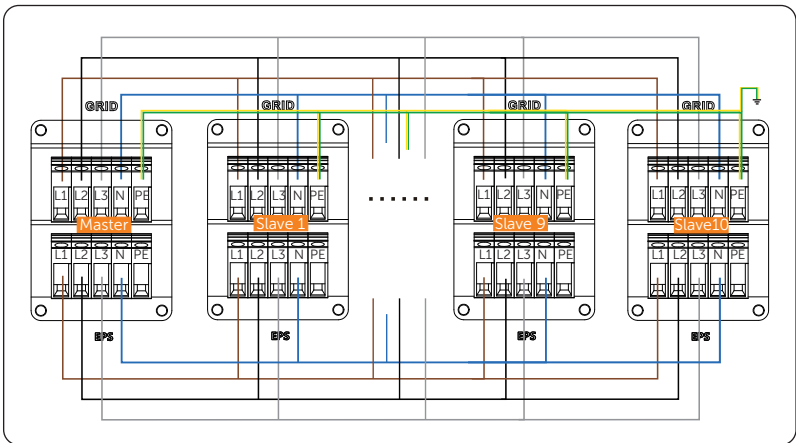

Figure 15-15 Power cable wiring with X3-PBOX device

- Communication cable wiring procedure :
 - a. Use standard network cables for Master-Slave inverter and Master-X3-PBOX device.
 - b. Master inverter CAN 1 connects to the COM terminal of X3-PBOX device.
 - c. Master inverter CAN 2 connects to Slave 1 inverter CAN 1.
 - d. Slave 1 CAN 2 connects to Slave 2 CAN 1; other inverters are connected in such way.
 - e. Meter connects to Meter/CT terminal of the Master inverter. Please refer to "[8.6.3 Meter/CT Connection](#)".

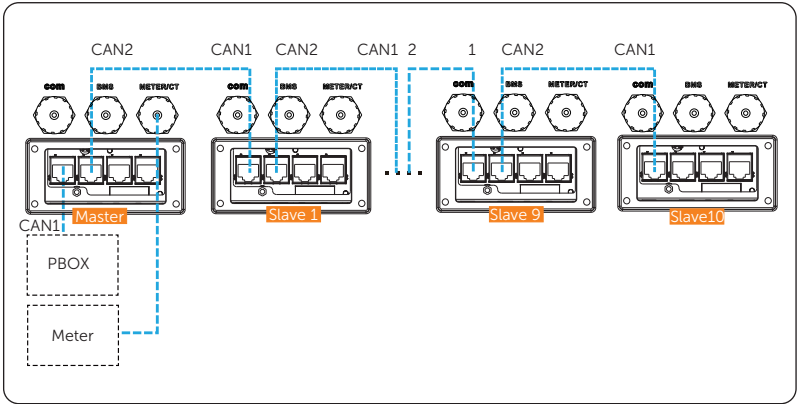

Figure 15-16 Communication wiring with X3-PBOX device

Without X3-PBOX device

- Power cable wiring procedure
 - a. User five-core copper cable (for grid connection) and four-core copper cable (for EPS (off-grid) connection) to connect Master-Slave inverter.
 - b. Grid connection terminal of Master and Slave inverter: L1 connects to L1, L2 connects to L2, L3 connects to L3 and N connects to N,
 - c. EPS (off-grid) connection terminal of Master and Slave inverter: L1 connects to L1, L2 connects to L2, L3 connects to L3 and N connects to N,
 - d. All PE cable connects to the E-BAR nearby.

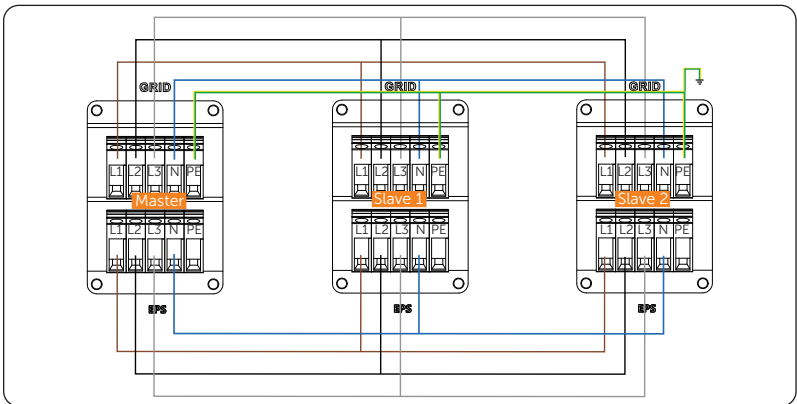

Figure 15-17 Power cable wiring without X3-PBOX device

- Communication cable wiring procedure :
 - a. Use standard network cables for Master-Slave inverter connection.
 - b. Master inverter CAN 2 connects to Slave 1 inverter CAN 1.
 - c. Slave 1 inverter CAN 2 connects to Slave 2 inverter CAN 1.
 - d. Meter connects to Meter/CT terminal of the Master inverter. Please refer to "[8.6.3 Meter/CT Connection](#)".

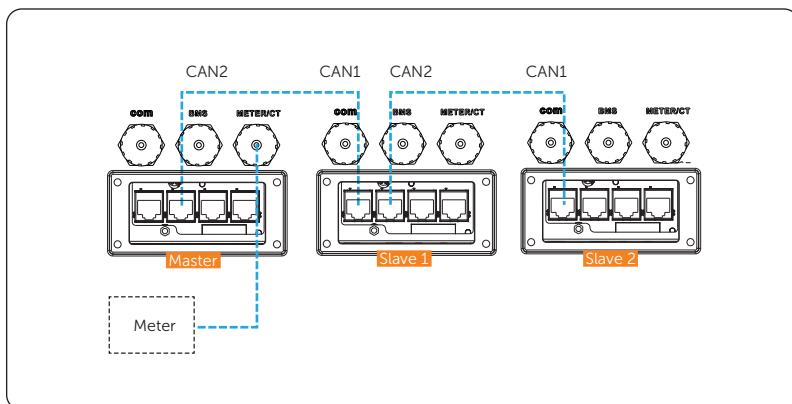

Figure 15-18 Communication wiring without X3-PBOX device

NOTICE!

- For details on the parallel connection of X3-PBOX device, see X3-PBOX-150kW-G2 X3-PBOX-60kW-G2 and installation guide.
- For details on the specific wiring of the inverter, see "[8.3 AC Connection](#)" and "[8.6.4 CAN1/CAN2/DRM/OFF Communication Connection](#)".

15.5.5 Settings for Parallel Connection

Meter/CT setting

Setting path: **Menu>Setting>Advance Setting>Meter/CT Setting**. For details, see "[Meter/CT Setting](#)".

Parallel setting

Setting path: **Menu>Setting>Advance Setting>Parallel Setting**.

How to build the parallel connection

- a. Turn on the power of the entire system, find the inverter which needs to be set as Master and connect the meter to Master inverter, enter the setting page of the Master inverter LCD screen, select the **Parallel Setting**, and select **Master**; then enter the **Resistance Switch** and set it to **ON**;

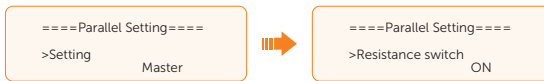

- b. Find the last slave in the parallel system and enter the setting page of the inverter LCD screen and set the **Resistance Switch** to **ON**.

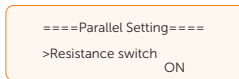

How to remove the parallel connection

- a. Find the inverter which needs to be set as **Free**. Select the **Parallel Settings** and select **Free** for the inverter.

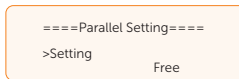

- b. Disconnect all the network cables on the CAN1 and CAN2 communication terminal.

NOTICE!

- If a slave inverter is set to **Free** mode but not disconnect the network cable, this inverter will return to **Slave** mode automatically.
- If a slave inverter is disconnected with master inverter but not be set to **Free** mode, this slave inverter will stop working and prompt **ParallelFault**.

External ATS setting

Setting path: **Menu>Setting>Advance Setting>External ATS**.

When the X3-PBOX-150K-G2 or X3-PBOX-60K-G2 is connected in the parallel system, enable the function.

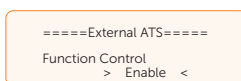

Parallel Status

Displaying path: **Menu>Parallel Status**

NOTICE!

- Once inverter enters parallel system, the **Today** yield will be replaced by **Parallel**.

In **Parallel Status** interface, the whole system power and individual slave inverter power can be obtained in **Parallel Status** interface of master inverter. The number displayed in the **Parallel Status** interface refers to the total number of online inverters, for example two inverters in parallel in the below figure.

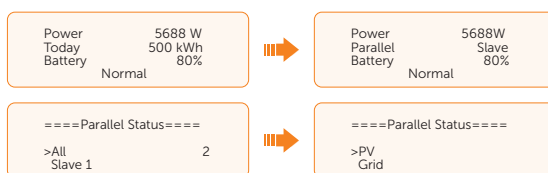

15.6 Meter/CT Connection Scenarios

X3-Hybrid G4 inverter series can be connected to a single batch of CTs, a direct-connected meter, or a CT-connected meter, and also supports a Meter 2 function for you to monitor another power generation equipment at home.

Followings are the detailed wiring and setting procedures of these scenarios. For wiring procedure of the inverter Meter/CT terminal, see "[8.6.3 Meter/CT Connection](#)".

15.6.1 Connection of CT

NOTICE!

- Do not place the CT on the N wire or ground wire.
- Do not place CT on the N line and L line at the same time.
- Do not place the CT on non-insulated wires.
- The cable length between CT and inverter should not exceed 100 meters.
- After CT is connected, prevent the CT clip from falling off. It is recommended to wrap the CT clip around in circles with insulating tape.

NOTICE!

- The CTs referred to in this section are the CT delivered with the inverter.

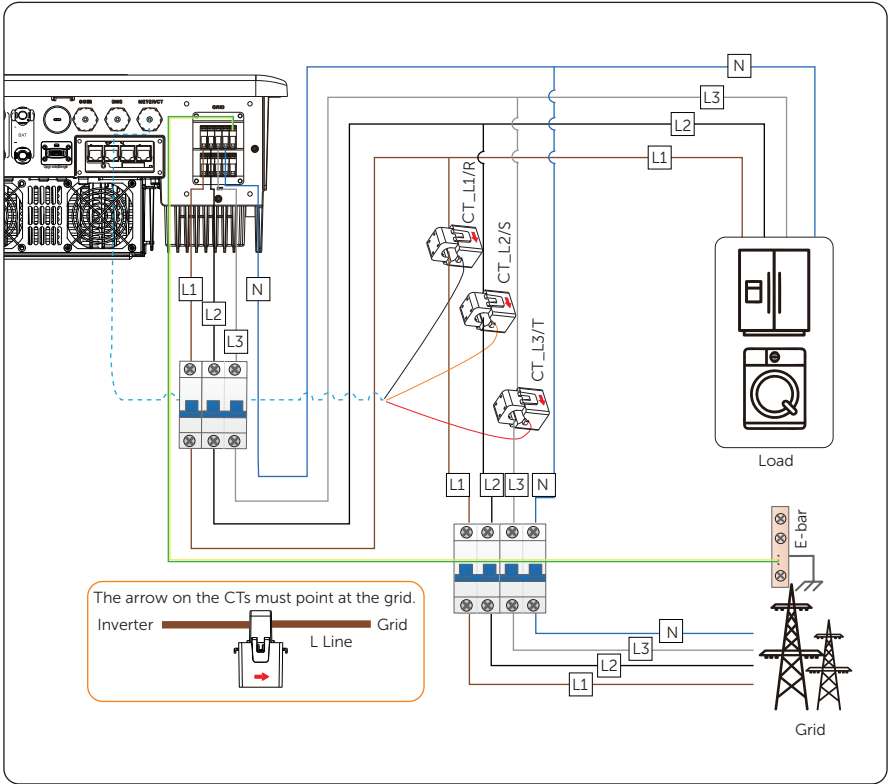

Figure 15-19 System wiring with CT

NOTICE!

- Markings on the CTs might be R, S and T or L1, L2 and L3. Make sure to clip CT-R/CT-L1 to the L1 wire, CT-S/CT-L2 to the L2 wire, and CT-T/CT-L3 to the L3 wire.
- The emergency load is connected to the EPS (off-grid) connection terminal of the inverter, which is not shown in the diagram.

Accessories required

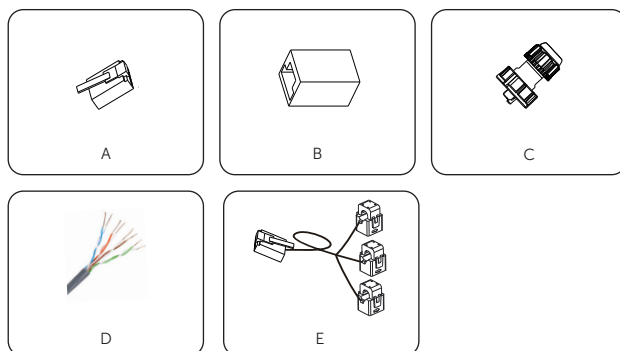

Figure 15-20 Accessories required

Figure 15-21 Accessories list

Item	Description	Quantity	Source
A	RJ45 terminal	1 pc	Delivered with inverter
B	RJ45 connector	1 pc	Delivered with inverter
C	Waterproof connectors with RJ45	1 pc	Delivered with inverter
D	CAT5E network cable	1 pc	Prepared by user
E	CT	1 pc	Delivered with inverter

Wiring Procedure

- Clip CT_L1, CT_L2 and CT_L3 respectively onto the L1, L2 and L3 cables of the grid. Make sure the arrow on the CTs is pointing to the grid side from the inverter.

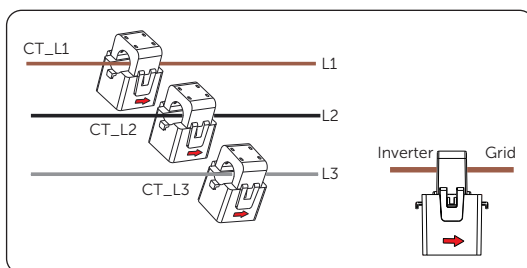

Figure 15-22 Clipping the CTs

- b. Use the RJ45 connector to connect the extension communication cable and the CTs.

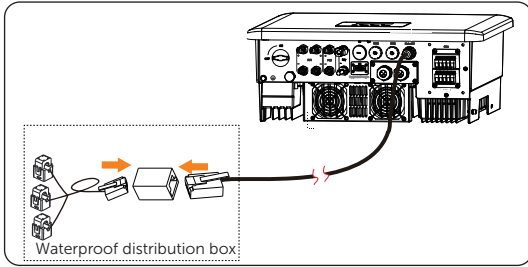

Figure 15-23 Connecting the inverter to the CT

Setting Procedure

After connecting CT to the inverter, set parameters on the inverter.

- a. CT is set by default.
- b. Select **Menu>Setting>Advance Setting>Meter/CT Setting** and enter the **Meter/CT Setting** interface according to the setting path to choose the supported CT type (100 A by default). You can check the connection status in **Meter/CT Check**.

```
====Meter/CTSetting====  
>CT Type  
100A
```

15.6.2 Connection of Direct-connected Meter

NOTICE!

- SolaX DTSU666 is used for example.

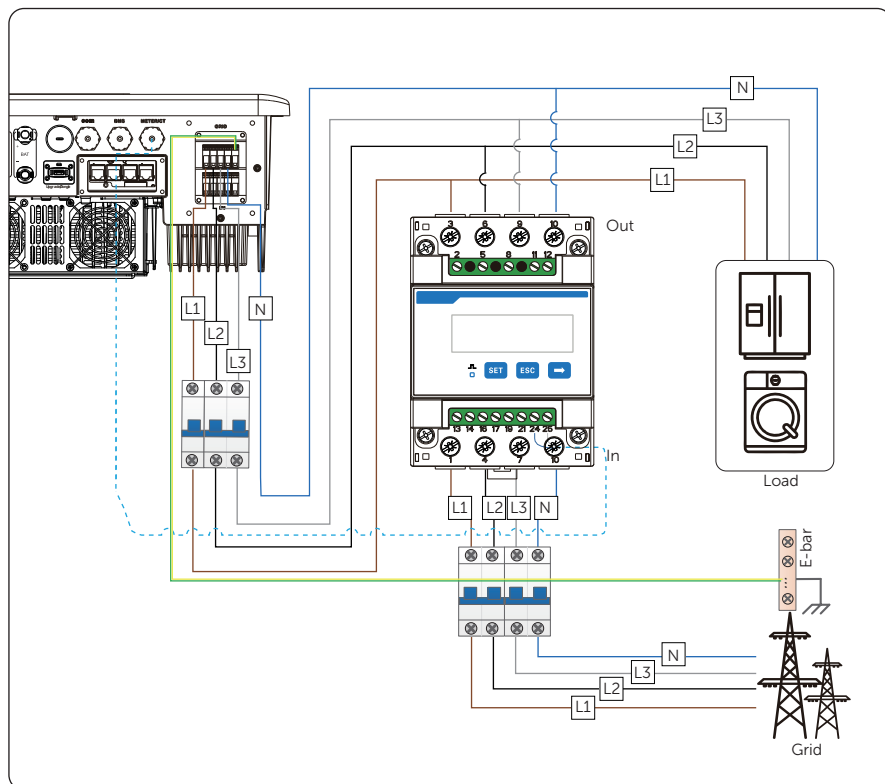

Figure 15-24 System wiring with direct-connected meter

NOTICE!

- For direct-connected meter, the current flow direction should be from grid to the inverter.
- Terminal 1, 4 and 7 of the meter must be connected to the grid side, and terminal 3, 6 and 9 be connected to the inverter side of the system. Otherwise, the system power data might be misread.

Accessories required



Figure 15-25 Accessories required

Figure 15-26 Accessories list

Item	Description	Quantity	Source
A	DTSU666	1 pc	
B	Two-core network cable	1 pc	Delivered with meter (Optional)
C	RJ45 terminal	1 pc	
D	Copper wire	/	Prepared by user
F	Waterproof connectors with RJ45	1 pc	Delivered with inverter

Wiring Procedure

- a. Strip around 10 mm wire insulation off the grid voltage cables, and then connect L1, L2 and L3 wires respectively to terminal 1 and 3, 4 and 6, 7 and 9, and N wire to terminal 10 of the meter.

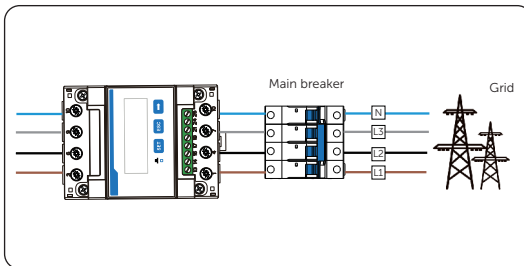

Figure 15-27 Connecting direct-connected meter to the grid

- b. Strip 10-15 mm wire insulation off the other end of the communication cable.

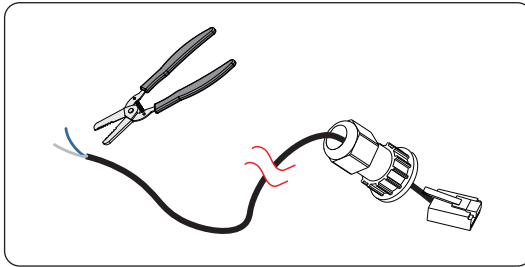

Figure 15-28 Stripping communication cable for meter

- c. Connect the conductors to terminal 24 and 25 of the meter.

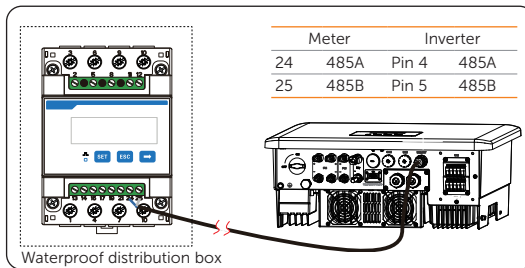

Figure 15-29 Connecting to meter

Setting Procedure

After connecting meter to the inverter, set parameters on the inverter.

- Select **Menu>Setting>Advance Setting>Meter/CT Setting** and enter the **Meter/CT Setting** interface according to the setting path.
- Enable the meter 1 selection and set the meter address and direction. You can check the connection status in **Meter/CT Check**.



15.6.3 Connection of CT-connected Meter

NOTICE!

- SolaX DTSU666-CT is used for example.
- The CTs referred to in this section are CTs that are delivered with the CT-connected meter.

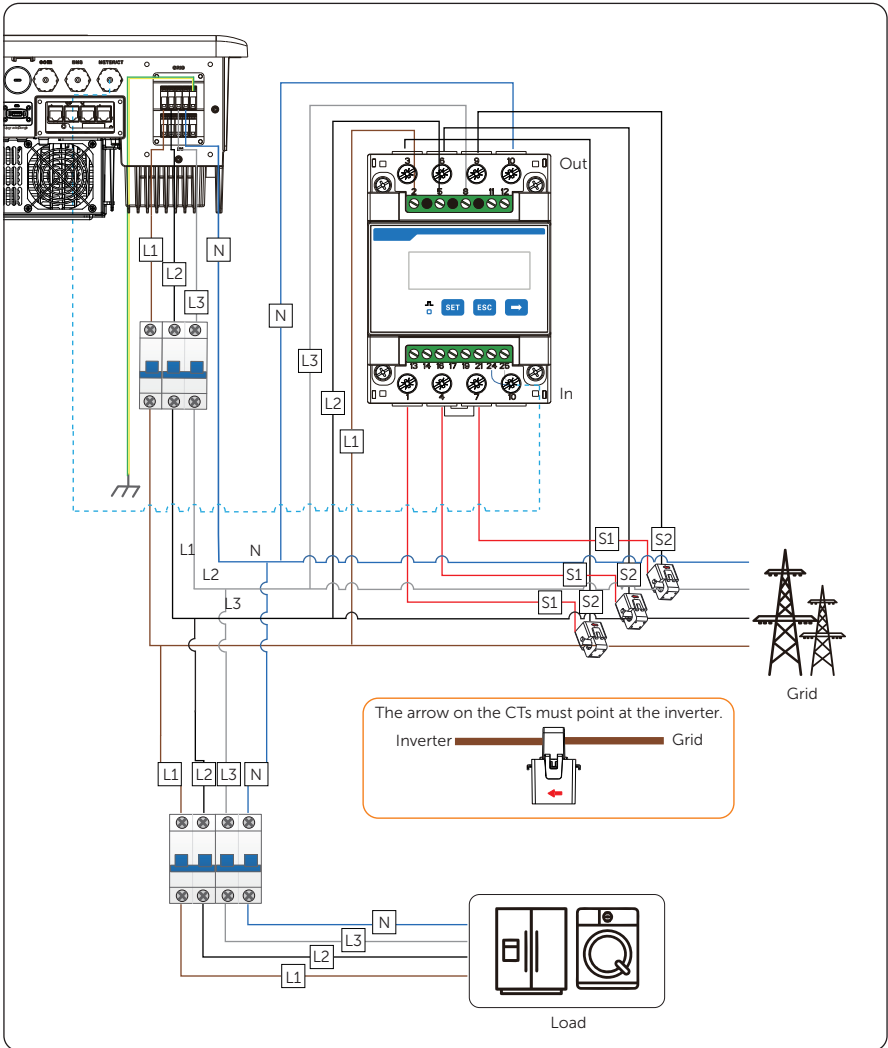

Figure 15-30 System wiring with CT-connected meter

NOTICE!

- Terminal 2, 5 and 8 of the meter must be connected to the grid side. Terminal 1, 4 and 7 must be connected to the S1 wire of the CTs, and terminal 3, 6 and 9 be connected to the S2 wire of the CTs. Otherwise, the system power data might be misread.
- The arrow on the CTs must point at the inverter side.

Accessories required

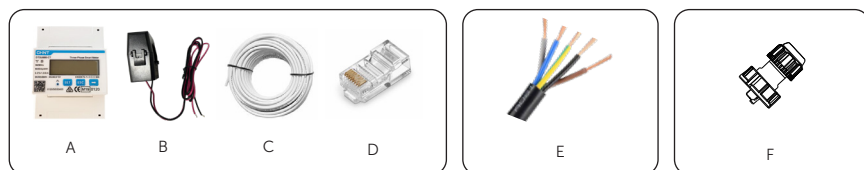

Figure 15-31 Accessories required

Figure 15-32 Accessories list

Item	Description	Quantity	Source
A	DTSU666-CT	1 pc	Delivered with meter (Optional)
B	CT	3 pcs	
C	Two-core network cable	1 pc	
D	RJ45 terminal	1 pc	
E	Copper wire	/	Prepared by user
F	Waterproof connectors with RJ45	1 pc	Delivered with inverter

Wiring Procedure

- Strip around 10 mm wire insulation off the voltage cables, and then connect L1, L2 and L3 wires respectively to terminal 2, 5 and 8, and the N wire to terminal 10 of the meter.
- Clip the CTs onto the L1, L2 and L3 wires in the direction from grid to inverter.
- Connect the S1 wire of the three included CTs respectively to terminal 1, terminal 4 and terminal 7, and S2 wire of the CTs respectively to terminal 3, 6 and 9 of the meter.
- Strip 10-15 mm wire insulation off the other end of the communication cable.

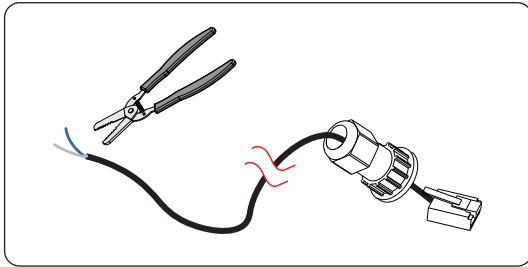

Figure 15-33 Stripping communication cable for meter

- e. Connect the conductors to terminal 24 and 25 of the meter.

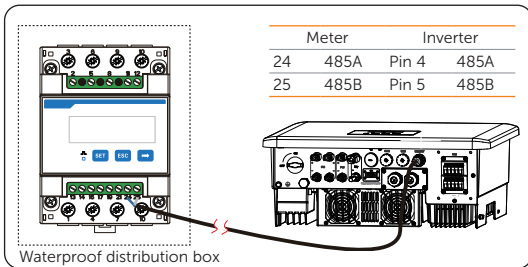

Figure 15-34 Connecting to meter

Setting Procedure

After connecting meter to the inverter, set parameters on the inverter.

- a. Select **Menu>Setting>Advance Setting>Meter/CT Setting** and enter the **Meter/CT Setting** interface according to the setting path.
- b. Enable the Meter 1 selection and set the meter address and direction. You can check the connection status in **Meter/CT Check**.



15.6.4 Connection of Two Meters

If you have another power generation equipment (such as an inverter) at home and wants to monitor both equipment, our inverter provides a Meter 2 Communication function to monitor the other power generation equipment.

NOTICE!

- For connecting CT and meter, or connecting two meters, prepare an RJ45 splitter adapter and a proper waterproof enclosure for it in advance.
- The device for monitoring the system (device at Meter 1 position) can be CT, direct connected meter and CT-connected meter, but the device for monitoring the other power generation equipment (device at Meter 2 position) can only be meters, either direct-connected meter or CT-connected meter. The following diagrams use the connection of CT and direct-connected meter for example.

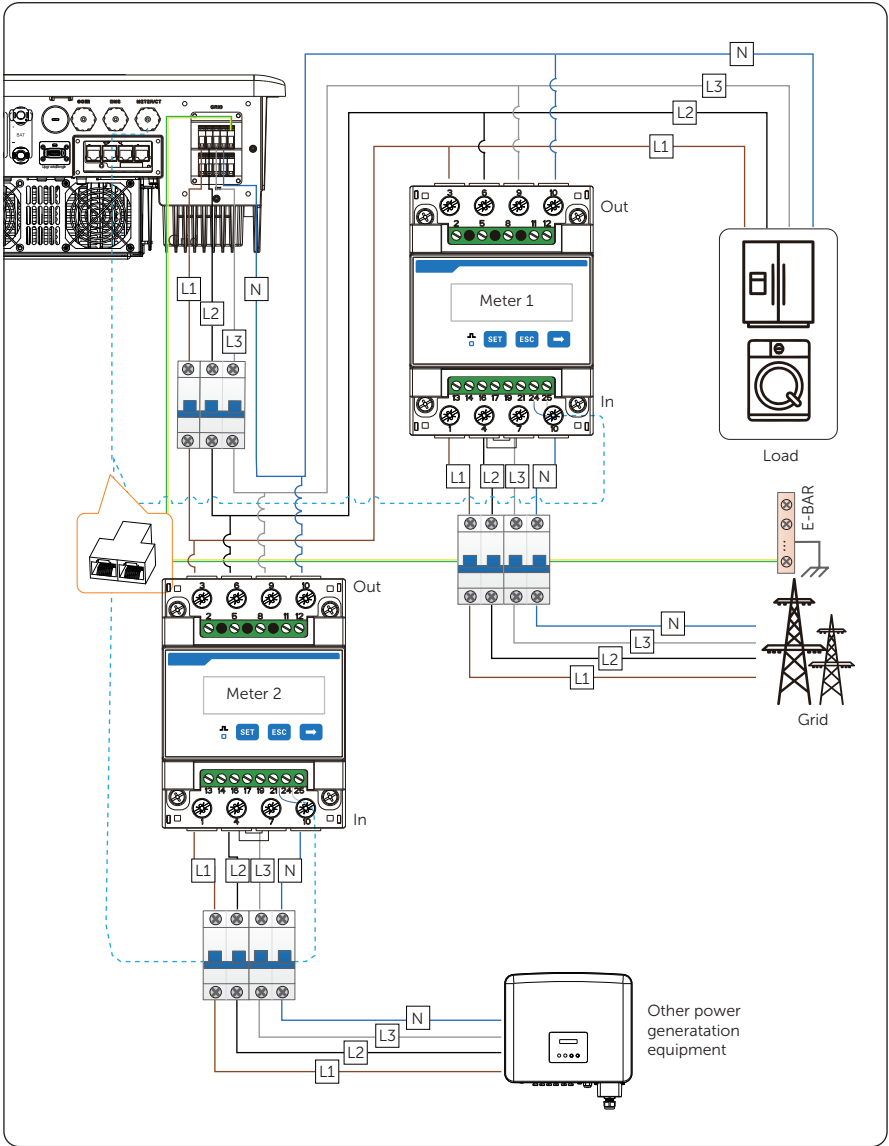

Figure 15-35 Connection diagram of two direct-connected meters

Accessories required for two direct-connected meters

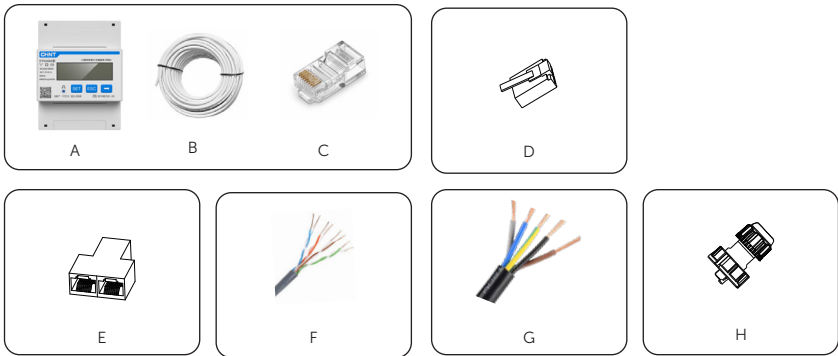

Figure 15-37 Accessories required

Figure 15-38 Accessories list

Item	Description	Quantity	Source
A	DTSU666		
B	Two-core network cable	2 sets	Delivered with meter (Optional)
C	RJ45 terminal		
D	RJ45 terminal	1 pc	Delivered with inverter
E	RJ45 splitter adapter	1	Prepared by user
F	CAT5E network cable	1	Prepared by user
G	Copper wire	/	Prepared by user
F	Waterproof connectors with RJ45	1 pc	Delivered with inverter

Wiring procedures for two direct-connected meters

- a. Connect the meter and inverter. For detailed steps, see ["15.6.2 Connection of Direct-connected Meter"](#). Please note that the RJ45 splitter adapter should be placed in a proper waterproof enclosure.

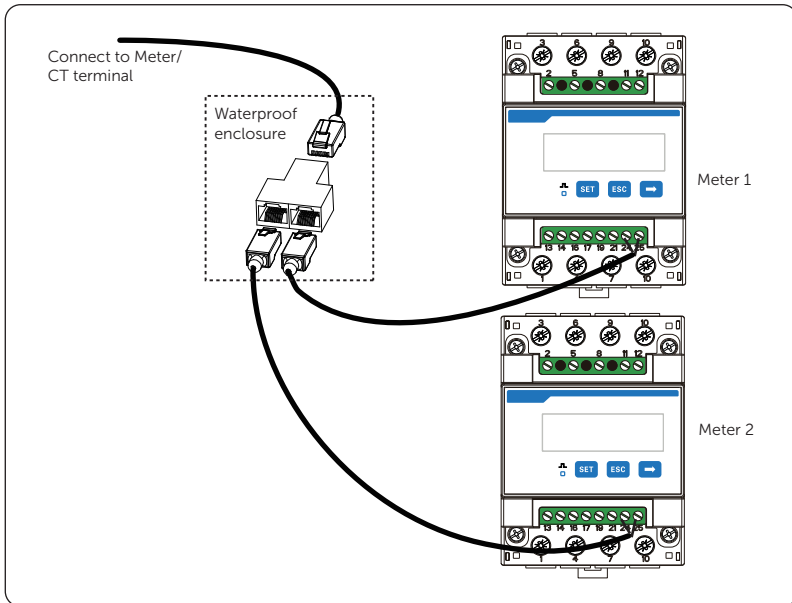

Figure 15-39 Connecting to RJ45 splitter adapter

Setting procedures for two direct-connected meters

How to set the parameters of meter 1 and meter 2

- Select **Menu>Setting>Advance Setting>Meter/CT Setting** and enter the **Meter/CT Setting** interface according to the setting path.
- Enable the meter 1 selection and set the meter address and direction. You can check the connection status in **Meter/CT Check**.



- Enable the meter 2 selection and set the meter address and direction.



How to check the power detected by Meter 1 and Meter 2

- a. Meter 1: Select **Menu>System Status>Meter/CT** and enter the **Meter/CT** interface according to the setting path. This interface displays the information including feed-in power of L1, L2 and L3 detected by the connected meter. Positive value with Pfeedin means power fed into grid; negative value means power taken from grid.



- a. Meter 2: Select **Menu>History Data>E_USERDEF** and enter the **E_USERDEF** interface according to the setting path. This interface displays the information including the output electricity of the connected on-grid inverter today and the total which is detected by Meter 2.

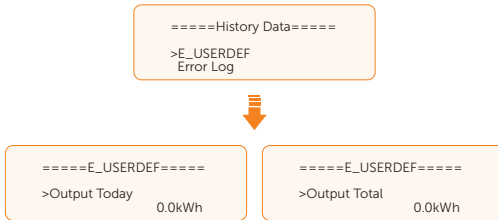

Accessories required for CT and direct-connected meter

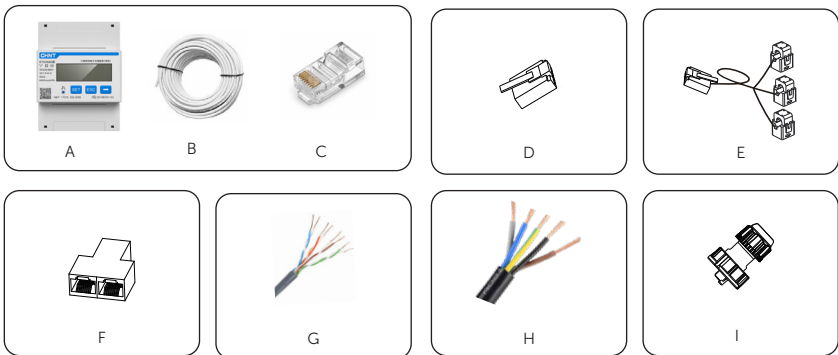

Figure 15-40 Accessories required

Figure 15-41 Accessories list

Item	Description	Quantity	Source
A	DTSU666		
B	Two-core network cable	1 set	Delivered with meter (Optional)
C	RJ45 terminal		
D	RJ45 terminal	1 pc	Delivered with inverter
E	CT	1 pc	Delivered with inverter
F	RJ45 splitter adapter	1 pc	Prepared by user
G	CAT5E network cable	1 pc	Prepared by user
H	Copper wire	/	Prepared by user
F	Waterproof connectors with RJ45	1 pc	Delivered with inverter

Wiring procedures for CT and direct-connected meter

- a. Connect the meter, CT and inverter. For detailed steps, see "[15.6.2 Connection of Direct-connected Meter](#)" and "[15.6.1 Connection of CT](#)". Please note that the RJ45 splitter adapter should be placed in a proper waterproof enclosure.

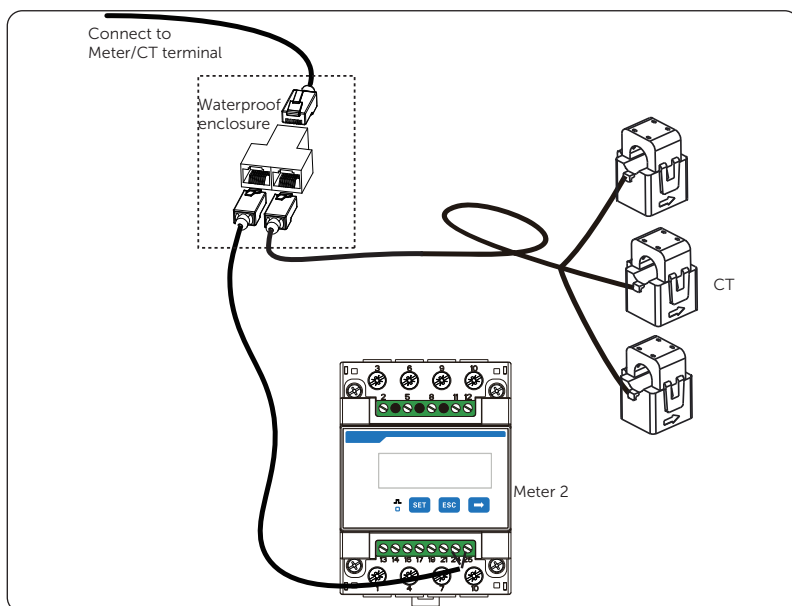
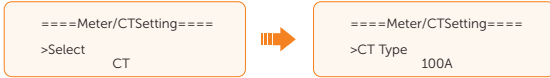

Figure 15-42 Connecting to RJ45 splitter adapter

Setting procedures for CT and direct-connected meter

How to set the parameters of CT and Meter 2

- Select **Menu>Setting>Advance Setting>Meter/CT Setting** and enter the **Meter/CT Setting** interface according to the setting path.
- CT is set by default. Choose the supported CT type. You can check the connection status in **Meter/CT Check**.



- Enable the meter 2 selection and set the meter address and direction.



How to check the power detected by Meter 1 and Meter 2

- Meter 1: Select **Menu>System Status>Meter/CT** and enter the **Meter/CT** interface according to the setting path. This interface displays the information including feed-in power of L1, L2 and L3 detected by the connected CT. Positive value with Pfeedin means power fed into grid; negative value means power taken from grid.



- Meter 2: Select **Menu>History Data>E_USERDEF** and enter the **E_USERDEF** interface according to the setting path. This interface displays the information including the output electricity of the connected on-grid inverter today and the total which is detected by Meter 2.

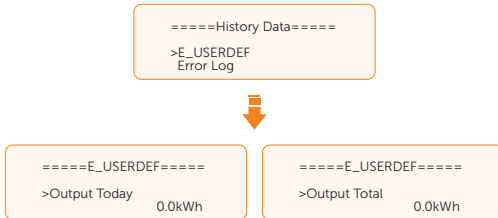

Contact Information



UNITED KINGDOM



Unit C-D Riversdale House, Riversdale
Road, Atherstone, CV9 1FA



+44 (0) 2476 586 998



service.uk@solaxpower.com



TURKEY



Fevzi Çakmak mah. aslım cd. no 88 A
Karatay / Konya / Türkiye



service.tr@solaxpower.com



USA



3780 Kilroy Airport Way, Suite 200, Long
Beach, CA, US 90806



+1 (408) 690 9464



info@solaxpower.com



POLAND



WARSAW AL. JANA P. II 27. POST



+48 662 430 292



service.pl@solaxpower.com



ITALY



+39 011 19800998



support@solaxpower.it



PAKISTAN



service.pk@solaxpower.com



AUSTRALIA



21 Nicholas Dr, Dandenong South VIC 3175



+61 1300 476 529



service@solaxpower.com



GERMANY



Am Tullnaupark 8, 90402 Nürnberg,
Germany



+49 (0) 6142 4091 664



service.eu@solaxpower.com



service.dach@solaxpower.com



NETHERLANDS



Twekkeler-Es 15 7547 ST Enschede



+31 (0) 8527 37932



service.eu@solaxpower.com



service.bnl@solaxpower.com



SPAIN



+34 9373 79607



tecnico@solaxpower.com



BRAZIL



+55 (34) 9667 0319



info@solaxpower.com



SOUTH AFRICA



service.za@solaxpower.com



SolaX Power Network Technology (Zhejiang) Co., Ltd.

Add.: No. 278, Shizhu Road, Chengnan Sub-district, Tonglu County,
Hangzhou, Zhejiang, China
E-mail: info@solaxpower.com

